

TABLE OF CONTENTS

1	INTRODUCTION	3
2	THINGS TO KNOW BEFORE STARTING YOUR VEHICLE	7
3	UNDERSTANDING THE FEATURES OF YOUR VEHICLE	27
4	UNDERSTANDING YOUR INSTRUMENT PANEL	53
5	STARTING AND OPERATING	65
6	WHAT TO DO IN EMERGENCIES	87
7	MAINTAINING YOUR VEHICLE	93
8	MAINTENANCE SCHEDULES	117
9	IF YOU NEED CONSUMER ASSISTANCE	139
10	INDEX	149

1

INTRODUCTION

- INTRODUCTION 4
 - Roll Over Warning 4
- IMPORTANT NOTICE 5
- HOW TO USE THIS MANUAL 6
- WARNINGS AND CAUTIONS 6
- VEHICLE IDENTIFICATION NUMBER 6

INTRODUCTION

Thank you for selecting one of our popular Jeep® models. Be assured that it represents precision workmanship, distinctive styling and high quality traditional with Jeep® vehicles.

This is a specialized utility vehicle designed for both on-road and off-road use. It can go places and perform tasks for which conventional 2-wheel drive vehicles were not intended. It handles and maneuvers differently from many passenger cars both on-road and off-road, so take time to become familiar with your vehicle.

Before you start to drive this vehicle, read the Owner's Manual and all the Supplements. Be sure you are familiar with all vehicle controls, particularly those used for braking, steering and transmission and transfer case shifting. Learn how your vehicle handles on different road surfaces. Your driving skills will improve with experience, but as in driving any vehicle, take it easy as you begin. When driving off-road or working the vehicle, don't overload it or expect it to overcome the forces of nature. Always observe local laws wherever you drive.

As with other vehicles of this type, failure to operate this vehicle correctly may result in loss of control or an accident. Be sure to read the "On-Road" and "Off-Road Driving Tips" in Section 5 of this manual.

Roll Over Warning

Utility vehicles have a significantly higher roll over rate than other types of vehicles. This vehicle has a higher ground clearance, higher center of gravity, and narrower track than many passenger cars. It is capable of performing better in a wide variety of off-road applications. Driven in an unsafe manner, all vehicles can be caused to go out of control. Because of the higher center of gravity and the narrower track, if this vehicle is out of control it may roll over when some other vehicles may not.

Do not attempt sharp turns at high speeds or abrupt maneuvers or other unsafe driving actions that can cause loss of vehicle control. Failure to operate this vehicle safely may result in an accident, roll over of the vehicle, and severe or fatal injury. Drive carefully.

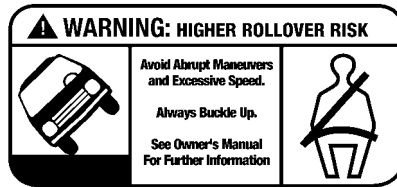

80bf0f0

Failure to use the driver and passenger seat belts provided as standard equipment on all vehicles is a major cause of serious injury or death. In a roll over crash an unbelted person is significantly more likely to die than a person wearing a seat belt. Always buckle up.

Operating this vehicle at excessive speeds or while intoxicated may result in loss of control, collision with other vehicles or objects, going off the road, or overturning; any of which may lead to serious injury or death. Also, failure to use the seat belts subjects the driver and passengers to a greater risk of injury in the event of an accident.

To keep your vehicle running at it's best, have your vehicle serviced at recommended intervals by an authorized Jeep® dealer or distributor who has the qualified personnel, special tools and equipment to perform all service. The manufacturer and its distributors are vitally interested in your complete satisfaction with this vehicle. If you encounter a service or warranty problem which is not resolved to your satisfaction, discuss the matter with your authorized Jeep® dealer or distributor's management.

Your authorized Jeep® dealer or distributor will be happy to assist you with any questions about your vehicle.

IMPORTANT NOTICE

ALL MATERIAL CONTAINED IN THIS PUBLICATION IS BASED ON THE LATEST INFORMATION AVAILABLE AT TIME OF PUBLICATION APPROVAL. THE RIGHT IS RESERVED TO PUBLISH REVISIONS AT ANY TIME.

This manual has been prepared with the assistance of service and engineering specialists to acquaint you with the operation and maintenance of your new vehicle. It is supplemented by a Warranty Information Booklet and various customer oriented documents. You are urged to read these publications carefully. Following the instructions and recommendations in this manual will help assure safe and enjoyable operation of your vehicle.

After you have read the manual, it should be stored in the vehicle for convenient reference and remain with the vehicle when sold.

The manufacturer reserves the right to make changes in design and specifications, and/or to make additions to or improvements in its products without imposing any obligations upon itself to install them on products previously manufactured.

The Owner's Manual illustrates and describes the features that are standard or available as extra cost options. Therefore, some of the equipment and accessories in this publication may not appear on your vehicle.

NOTE:

Be sure to read the Owner's Manual first before driving your vehicle and before attaching or installing parts/accessories or making other modifications to the vehicle.

In view of the many replacement parts and accessories from various manufacturers available on the market, the manufacturer cannot be certain that the driving safety of your vehicle will not be impaired by the attachment or installation of such parts. Even if such parts are officially approved (for example, by a general operating permit for the part or by constructing the part in an officially approved design), or if an individual operating permit was issued for the vehicle after the attachment or installation of such parts, it cannot be implicitly assumed that the driving safety of your vehicle is unimpaired. Therefore, neither experts nor official agencies are liable. The manufacturer only assumes responsibility therefore when parts which are expressly authorized or recommended by the manufacturer are attached or installed at an authorized dealer. The same applies when

modifications to the original condition are subsequently made on the manufacturer's vehicles.

Your warranties do not cover any part that the manufacturer did not supply. Nor do they cover the cost of any repairs or adjustments that might be caused or needed because of the installation or use of non-manufacturer parts, components, equipment, materials or additives. Nor do your warranties cover the costs of repairing damage or conditions caused by any changes to your car that do not comply with the manufacturer's specifications.

Original Mopar parts and accessories and other products approved by the manufacturer, including qualified advice, are available at your authorized dealer.

When it comes to service, remember that your dealer knows your vehicle best, has the factory-trained technicians and genuine Mopar parts and is interested in your satisfaction.

Copyright © 2002 Chrysler

HOW TO USE THIS MANUAL

Consult the table of contents to determine which section contains the information you desire.

The detailed index, at the rear of the manual, contains a complete listing of all subjects.

WARNINGS AND CAUTIONS

This manual contains **WARNINGS** against operating procedures which could result in an accident or bodily injury. It also contains **CAUTIONS** against procedures which could result in damage to your vehicle. If you do not read this entire manual you may miss important information. Observe all Warnings and Cautions.

VEHICLE IDENTIFICATION NUMBER

The vehicle identification number (VIN) is found on a stamped plate located on the left front corner of the instrument panel pad, visible from outside of the vehicle through the windshield.

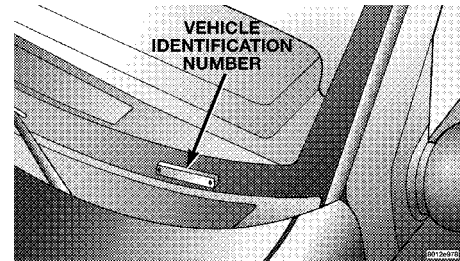

NOTE:

Do not tamper with the VIN plate.

THINGS TO KNOW BEFORE STARTING YOUR VEHICLE

• A WORD ABOUT YOUR KEYS	9
• Ignition Key	9
• Key-In-Ignition Reminder	9
• SENTRY KEY IMMOBILIZER SYSTEM	9
• General Information	10
• ILLUMINATED ENTRY	10
• DOOR AND LIFTGATE LOCKS	10
• Liftgate Flipper Glass	10
• Door Locks	11
• Power Door Lock System	11
• REMOTE KEYLESS ENTRY	12
• To Unlock the Doors and Liftgate	12
• To Lock the Doors and Liftgate	12
• General Information	12
• Programming Additional Transmitters	12
• Transmitter Battery Replacement	12
• SECURITY ALARM SYSTEM — IF EQUIPPED	13
• To Set the Alarm	13

- To Disarm the System 13
- **POWER WINDOWS** 14
 - Wind Buffeting 14
- **OCCUPANT RESTRAINTS** 15
 - Lap/Shoulder Belts 15
 - Lap/Shoulder Belt Operating Instructions 15
 - Adjustable Upper Shoulder Belt Anchorage 17
 - Automatic Locking Mode — If Equipped 17
 - Energy Management Feature 17
 - Seat Belts and Pregnant Women 18
 - Driver And Front Passenger Supplemental Restraint Systems (SRS) — Airbags 18
 - Child Restraint 22
- **ENGINE BREAK-IN RECOMMENDATIONS** 24
- **SAFETY TIPS** 25
 - Exhaust Gas 25
 - Safety Checks You Should Make Inside The Vehicle . . . 25
 - Safety Checks You Should Make Outside The Vehicle . . 25

A WORD ABOUT YOUR KEYS

The keys for your new vehicle are enclosed in a plastic bag with the key code number on it. If you received your keys without the bag, ask your authorized dealer to give you the number. The key code can also be obtained by your authorized dealer from your vehicle invoice.

Ignition Key

Insert the key fully, then turn the switch to one of the four illustrated positions. The key can be inserted or withdrawn only in the LOCK position. The gearshift lever must be in the P (Park) position.

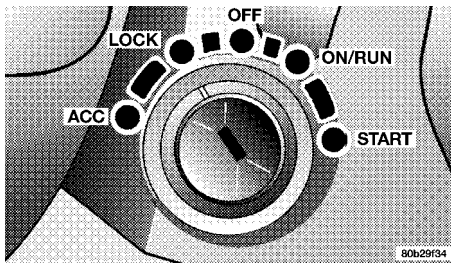

To remove the ignition key, place the gearshift lever in P (Park), turn the ignition key to LOCK and remove the key.

Key-In-Ignition Reminder

If the driver's door is opened when the key is in the ignition and not turned to the ON position, a chime will sound to remind you to remove the key.

CAUTION!

Always remove the key from the ignition, and lock all doors when leaving the vehicle unattended.

SENTRY KEY IMMOBILIZER SYSTEM

The Sentry Key Immobilizer System (SKIS) prevents unauthorized operation of the vehicle by disabling the engine. The system will shut the engine down after 2 seconds of running if an invalid key is used to start the vehicle. This system utilizes ignition keys which have an electronic chip (transponder) embedded into them. Only keys that have been programmed to the vehicle can be used to start and operate the vehicle for longer than the 2 second validation time period.

The Sentry Key Immobilizer System does not need to be armed or activated. Operation of the system is automatic regardless of whether or not the vehicle is locked or unlocked. During normal operation, the SKIS indicator light will come on for 3 seconds immediately after the ignition switch is turned on for a bulb check. Afterwards, if the bulb

remains on, this indicates a malfunction in the electronics. If the bulb begins to flash immediately after the ignition switch has been turned on, this indicates that an invalid key has been used to start the vehicle. Both of these conditions will result in the engine being shut down after 2 seconds of running. Keep in mind that a key which has not been programmed is also considered an invalid key even if it is cut to fit the ignition for that vehicle.

If the SKIS indicator light comes on during normal vehicle operation (it has been running for longer than 10 seconds) a fault has been detected in the electronics. If this occurs, **DO NOT TURN THE IGNITION OFF** since this failure will result in the vehicle being shut down on each subsequent ignition cycle. Take the vehicle directly to your authorized dealer for service.

NOTE:

A four digit PIN is needed to service the Sentry Key Immobilizer System. This number can be obtained by your authorized dealer. YOU MUST BRING ALL SENTRY KEYS that are programmed to your vehicle with you when bringing your vehicle in for service.

General Information

Hereby, Siemens AG, Automotive Systems Group, Access Control and Security Systems, declares that the Sentry Key Immobilizer is in compliance with the essential requirements and other relevant provisions of Directive 1999/5/EC.

The Sentry Key Immobilizer is a 134 kHz system. It will be used in the following European countries, which apply Directive 1999/5/EC: Austria, Belgium, Czech Republic, Denmark, Finland, France, Germany, Greece, Hungary, Ireland, Italy, Luxembourg, Netherlands, Norway, Poland, Portugal, Romania, Russian Federation, Slovenia, Spain, Sweden, Switzerland, Yugoslavia, and United Kingdom.

To view the original Declaration of Conformity, visit http://www.siemensauto.com/glossaries/skim_ec.html on the Internet.

Operation is subject to the following two conditions:

1. This device may not cause harmful interference.
2. This device must accept any interference that may be received, including interference that may cause undesired operation.

ILLUMINATED ENTRY

The interior lights come on when you open any door. They will remain on for about 30 seconds after all doors are closed then fade to off.

The lights also will fade to off if you turn on the ignition after you close all the doors.

DOOR AND LIFTGATE LOCKS

NOTE:

The master key that is used to start the vehicle is used to lock or unlock the driver's door. To unlock the driver's door insert the key into the lock and turn.

To open the liftgate, pull out on the handle and lift.

WARNING!

Driving with the liftgate open can allow poisonous exhaust gases into your vehicle. You and your passengers could be injured by these fumes. Keep the liftgate closed when you are operating the vehicle.

Liftgate Flipper Glass

The liftgate flipper glass is also unlocked when the liftgate is unlocked. To open the flipper glass, push up on the window switch located on the liftgate. Once the liftgate flipper glass has been opened, connection to the rear window wiper is

interrupted, preventing activation of the rear wiper blade while the flipper glass is open.

NOTE:

If a power malfunction to the power liftgate latch should occur, an emergency liftgate latch release can be used to open the liftgate. The emergency liftgate latch release can be accessed through a snap-in cover located on the liftgate trim panel.

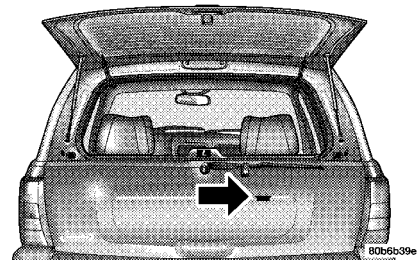

WARNING!

Driving with the flipper glass open can allow poisonous exhaust gases into your vehicle. You and your passengers could be injured by these fumes. Keep the flipper glass closed when you are operating the vehicle.

Door Locks

All doors are equipped with a slide-type interior door lock. To manually lock a door, slide the lever rearward (toward the rear of the vehicle) to the "Lock" position.

Once locked, the rear doors cannot be opened from the inside until the lock lever has been released. However, the front doors can be opened using the inside door handle.

To manually unlock a door, slide the lever forward (toward the front of the vehicle) to the "Unlock" position.

WARNING!

For personal security reasons and safety in a collision, lock the vehicle doors when you drive and when you park and leave the vehicle.

Child Protection Locks

The rear doors of your vehicle are equipped with child protection locks. If you push up on the lever on the open edge of the door it cannot be opened from the inside of the vehicle. Push the lever down to disengage the child protection locks.

WARNING!

Avoid trapping anyone in the vehicle in a collision. Remember that the rear doors can only be opened from the outside when the child protection locks are engaged.

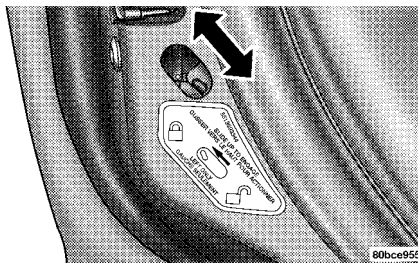

Power Door Lock System

The power door locks are on a paddle-type switch. Pressing the switch toward the rear of the vehicle will "Lock" all doors. Pressing the switch toward the front of the vehicle will "Unlock" all doors. The driver's and passenger's switch locks and unlocks all doors and the liftgate.

As a safety feature, the power door lock switch will not lock when the door is open and the key is in the ignition.

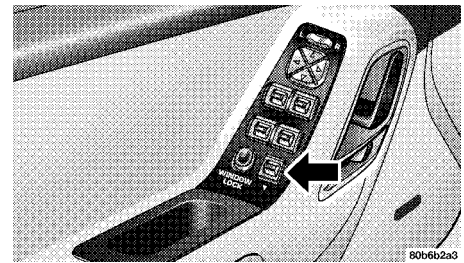

Once locked, the rear doors cannot be opened from the inside until the lock lever has been released. However, both front doors can be opened using the inside door handle.

Automatic Door Locks

If this feature is selected your door locks will lock automatically if the vehicle speed is above 24 km/h (15 mph) and all doors are closed. It will reset whenever a door is opened.

This feature is selectable and can be turned on or off. Refer to "Overhead Console — Customer Programmable Features" in Section 3 of this manual or see your authorized dealer.

Automatic Unlock on Exit Feature — Only Available if Auto Lock is Enabled

This feature will unlock all the doors when the driver's door is opened if the vehicle is stopped and in P (Park) or N (Neutral). Refer to "Overhead Console — Customer Programmable Features" in Section 3 of this manual or see your authorized dealer.

REMOTE KEYLESS ENTRY

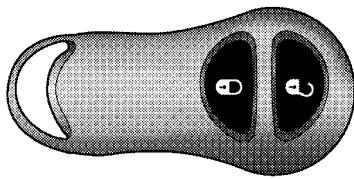

806610F

This system allows you to lock or unlock the doors and liftgate from distances up to about 7 meters (23 feet) using a hand held radio transmitter. The transmitter need not be pointed at the vehicle to activate the system.

To Unlock the Doors and Liftgate

Press and release the "Unlock" button on the key fob once to unlock the driver's door, or twice to

unlock all doors and liftgate. The illuminated entry system will also come on.

NOTE:

The system can be programmed to do the following:

- unlock all the doors on the first button press
- flash the turn signals twice with unlock
- On vehicles equipped with an overhead console these functions can be selected at the overhead console using the "Customer Programmable Features." Refer to "Customer Programmable Features" in the Overhead Console section, otherwise see your authorized dealer.

To Lock the Doors and Liftgate

Press and release the "Lock" button on the key fob to lock all doors and liftgate. If you wish, the turn signals can be programmed to flash once to show the system is activated. For customer programmable features refer to the section on "Overhead Console" for programming details, otherwise see your authorized dealer.

General Information

Hereby, TRW Automotive, Electronics Group, declares that the Remote Keyless Entry is in compliance with the essential requirements and other relevant provisions of Directive 1999/5/EC.

The Remote Keyless Entry is a 433.92 Mhz system. It will be used in the following European countries, which apply Directive 1999/5/EC: Austria, Belgium, Czech Republic, Denmark, Finland, France, Germany, Greece, Hungary, Ireland, Italy, Luxembourg, Netherlands, Norway, Poland, Portugal, Romania, Russian Federation, Slovenia, Spain, Sweden, Switzerland, Yugoslavia, and United Kingdom.

Operation is subject to the following two conditions:

1. This device may not cause harmful interference.
2. This device must accept any interference that may be received, including interference that may cause undesired operation.

Programming Additional Transmitters

Up to four transmitters can be programmed. See your authorized dealer.

Transmitter Battery Replacement

The recommended replacement battery is a Panasonic CR2016 or equivalent.

NOTE:

Do not touch the battery terminals that are on the back housing or the printed circuit board.

1. With the transmitter buttons facing down, use a thin coin to pry the two halves of the transmitter apart. Make sure not to damage the rubber gasket during removal.

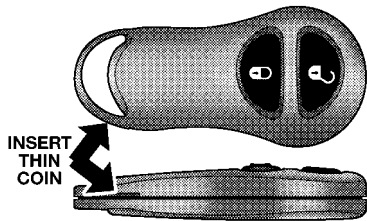

80b76e5e

2. Remove and replace the batteries. Avoid touching the new batteries with your fingers. Skin oils may cause battery deterioration. If you touch a battery, clean it with rubbing alcohol.
3. To reassemble the transmitter case snap two halves together. Make sure there is an even "gap" between the two halves.
4. Reset the transmitter by pressing the unlock button six times. Test the transmitter operation.

SECURITY ALARM SYSTEM — IF EQUIPPED

The vehicle security alarm system is available in a base or premium version. Both versions of these systems monitor the vehicle doors, liftgate, liftgate flipper glass, hood, and ignition status for unauthorized operation. In addition, the premium system monitors motion inside of the vehicle. When the alarm is activated, the system provides both audible and visual signals. In the base version, the horn and exterior lights will pulse for 25 seconds. In the premium version, the exterior lights and siren will pulse for 25 seconds. If disturbance is still present, the siren will pulse for another 25 seconds. This will continue for a maximum of 10 cycles.

To Set the Alarm

The alarm will set when you use the remote keyless entry transmitter to lock the doors and liftgate or when you use the power door lock switch while the door is open. After all the doors are locked and closed, a red light on the instrument panel will flash rapidly for about 16 seconds to signal that the system is arming. During this 16 second arming period, opening any door, the liftgate, or hood will cancel the arming. If the system successfully arms, the red light will flash at a slower rate to indicate the alarm is set. If the hood is left open during arming, the hood will be ignored as an input until closed. The motion

detect feature (premium model only) can be disabled by pressing the "Lock" button on the transmitter 3 times within 16 seconds during system arming. The system will provide a single siren "chirp" as an audible confirmation of motion disable.

To Disarm the System

To disarm the system, use the remote keyless entry transmitter to unlock the door's. If something has triggered the system in your absence, the horn (base model only) or siren (premium model only) will sound three times when you unlock the doors. Check the vehicle for tampering.

The Security Alarm System is designed to protect your vehicle; however, you can create conditions where the system will alarm unexpectedly. If the system is armed and you unlock the driver's door, passenger door, or liftgate using a key and then open it, or if you remain in the vehicle and lock the doors with the transmitter the system will arm. The alarm will then sound when you pull the door handle to exit or if you move inside the vehicle (premium model only). If this occurs, press the "Unlock" button on the remote keyless entry transmitter to disarm the system. If the key is used to lock the vehicle, the door will be locked but the Security Alarm will not arm.

NOTE:

In order to avoid false alarms (premium model only), keep all windows and sunroof (if equipped) closed while the system is armed.

POWER WINDOWS

An individual lever-type switch controls each side window. Push the lever down to lower a window and push the lever up to raise it. Window controls on the driver's door control all door windows. A lockout control allows only the driver to operate the windows.

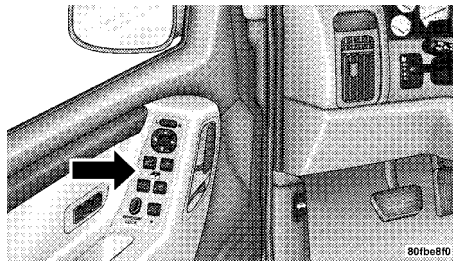

WARNING!

Never leave children in a vehicle, with the keys in the ignition switch. Occupants, particularly unattended children can become entrapped by the windows while operating the power window switches. Such entrapment may result in serious injury or death.

NOTE:

The electrical power windows are protected by an overload circuit breaker. This circuit breaker will reset itself automatically. However, in an emergency situation, it might require a few seconds of not operating the window switch, in the up or down position, before the windows will be able to operate.

NOTE:

A small light in each passenger's window switch turns on and off with the lockout switch showing if the windows are enabled or disabled.

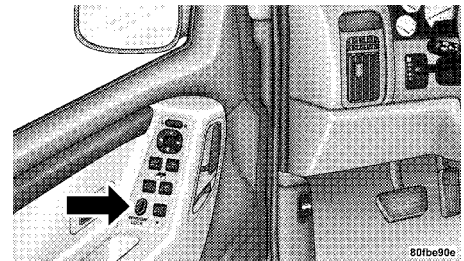

The driver's window switch has an "Auto Down" feature. Press the window switch past the detent, release, and the window will go down automatically.

The power window switches remain active for up to 45 seconds after the ignition key has been turned OFF. Opening a vehicle front door will cancel this feature.

Wind Buffeting

Wind buffeting can be described as the perception of pressure on the ears or a helicopter type sound in the ears. Your vehicle may exhibit wind buffeting with the windows down, or the sunroof (if so equipped) in certain open or partially open positions. This is a normal occurrence and can be minimized. If the buffeting occurs with the sunroof open, adjust the sunroof opening to minimize the buffeting.

OCCUPANT RESTRAINTS

Some of the most important safety features in your vehicle are the restraint systems. These include the front and rear seat belts for the driver and all passengers, and front airbags for both the driver and right front passenger. If you will be carrying children too small for adult-size belts, your seat belts also can be used to hold infant and child restraint systems.

NOTE:

The front airbags have a multi stage inflator design. This allows the airbag to have different rates of inflation that are based on collision severity.

Please pay close attention to the information in this section. It tells you how to use your restraint system properly to keep you and your passengers as safe as possible.

WARNING!

In a collision, you and your passengers can suffer injuries, including fatalities, if you are not properly buckled up. You can strike the interior of your vehicle or other passengers, or you can be thrown out of the vehicle. Always be sure you and others in your vehicle are buckled up properly.

Buckle up even though you are an excellent driver, even on short trips. Someone on the road may be a poor driver and cause a collision which includes you. This can happen far away from home or on your own street.

Research has shown that seat belts save lives, and they can reduce the seriousness of injuries in a collision. Some of the worst injuries happen when people are thrown from the vehicle. Seat belts reduce the possibility of ejection and the risk of injury caused by striking the inside of the vehicle. **Everyone** in a motor vehicle should be belted at all times to reduce or prevent injuries.

Lap/Shoulder Belts

The front and rear seats of your vehicle have combination lap/shoulder belts.

The belt webbing retractor is designed to lock during very sudden stops or collisions. This feature allows the shoulder part of the belt to move freely with you under normal conditions. But in a collision, the belt will lock and reduce the risk of you striking the inside of the vehicle or being thrown out.

WARNING!

- Wearing a seat belt incorrectly is dangerous. Seat belts are designed to go around the large bones of your body. These are the strongest parts of your body and can take the forces of a collision the best. Wearing your belt in the wrong place could make your injuries in a collision much worse. You might suffer internal injuries, or you could even slide out of part of the belt. Follow these instructions to wear your seat belt safely and to keep your passengers safe, too.
- Two people should never be belted into a single seat belt. People belted together can crash into one another in an accident, hurting one another badly. Never use a lap/shoulder belt or a lap belt for more than one person, no matter what their size.

Lap/Shoulder Belt Operating Instructions

1. Enter the vehicle and close the door. Sit back and adjust the seat.

2. The seat belt latch plate is above the back of your seat. Grasp the latch plate and pull out the belt. Slide the latch plate up the webbing as far as necessary to make the belt go around your lap.

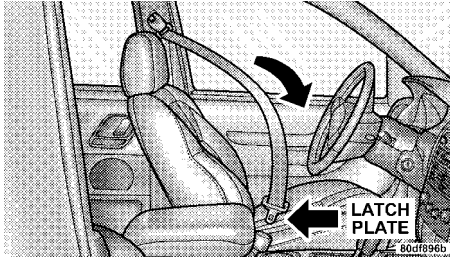

3. When the belt is long enough to fit, insert the latch plate into the buckle until you hear a "click."

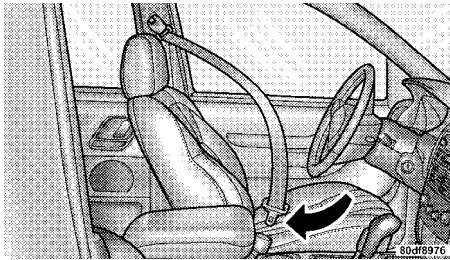

WARNING!

A belt that is buckled into the wrong buckle will not protect you properly. The lap portion could ride too high on your body, possibly causing internal injuries. Always buckle your belt into the buckle nearest you.

A belt that is too loose will not protect you as well. In a sudden stop you could move too far forward, increasing the possibility of injury. Wear your seat belt snugly.

A belt that is worn under your arm is very dangerous. Your body could strike the inside surfaces of the vehicle in a collision, increasing head and neck injury. A belt worn under the arm can cause internal injuries. Ribs aren't as strong as shoulder bones. Wear the belt over your shoulder so that your strongest bones will take the force in a collision.

A shoulder belt placed behind will not protect you from injury during a collision. You are more likely to hit your head in a collision if you do not wear your shoulder belt. The lap and shoulder belt are meant to be used together.

4. Position the lap belt across your thighs, below your abdomen. To remove slack in the lap portion, pull up a bit on the shoulder belt. To loosen the lap belt if it is too tight, tilt the latch plate and pull on the lap belt. A snug belt reduces the risk of sliding under the belt in a collision.

WARNING!

A lap belt worn too high can increase the risk of injury in a collision. The belt forces won't be at the strong hip and pelvic bones, but across your abdomen. Always wear the lap part of your seat belt as low as possible and keep it snug.

A twisted belt can't do its job as well. In a collision it could even cut into you. Be sure the belt is straight. If you can't straighten a belt in your vehicle, take it to your authorized dealer and have it fixed.

5. Position the shoulder belt on your chest so that it is comfortable and not resting on your neck. The retractor will withdraw any slack in the belt.

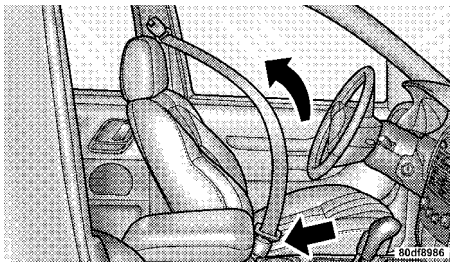

6. To release the belt, push the red button marked PRESS on the buckle. The belt will automatically retract to its stowed position. If necessary, slide the latch plate down the webbing to allow it to retract fully.

WARNING!

A frayed or torn belt could rip apart in a collision and leave you with no protection. Inspect the belt system periodically, checking for cuts, frays, or loose parts. Damaged parts must be replaced immediately. Do not disassemble or modify the system. Seat belt assemblies must be replaced after an accident if they have been damaged (bent retractor, torn webbing, etc.).

Adjustable Upper Shoulder Belt Anchorage

In the front seat positions, the shoulder belt can be adjusted upward or downward to position the belt away from your neck. Press on the release button to release the anchorage, and then move it up or down to the position that serves you best.

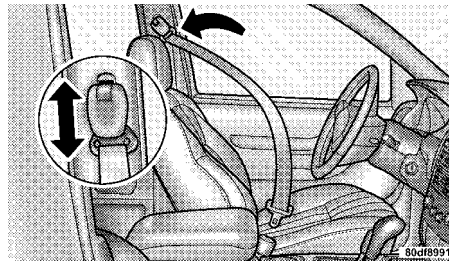

As a guide, if you are shorter than average, you will prefer a lower position, and if you are taller than average, you'll prefer a higher position. When you release the anchorage, try to move it up or down to make sure that it is locked in position.

Automatic Locking Mode — If Equipped

In this mode, the shoulder belt is automatically pre-locked. The belt will still retract to remove any slack in the shoulder belt.

When To Use The Automatic Locking Mode

Anytime a child safety seat is installed in a passenger front seating position. Children 12 years old and under should be properly restrained in the rear seat whenever possible.

How To Use The Automatic Locking Mode

1. Buckle the combination lap and shoulder belt.
2. Grasp the shoulder portion and pull downward until the entire belt is extracted.
3. Allow the belt to retract. As the belt retracts, you will hear a clicking sound. This indicates the safety belt is now in the automatic locking mode.

How to Disengage The Automatic Locking Mode

Disconnect the combination lap/shoulder belt and allow it to retract completely to disengage the automatic locking mode and activate the vehicle sensitive (emergency) locking mode.

Energy Management Feature

This vehicle has a safety belt system with an energy management feature in the front seating positions to help further reduce the risk of injury in the event of a head-on collision.

This safety belt system has a retractor assembly that is designed to pay out webbing in a controlled manner. This feature is designed to help reduce the belt force acting on the occupant's chest.

WARNING!

- After a vehicle collision, the front passenger outboard seat belt system must be checked by a qualified technician to verify that the “automatic locking retractor” feature for child seats is still functioning properly. In addition, all seat belts should be checked for proper function.
- The belt and retractor assembly must be replaced if the seat belt assembly “automatic locking retractor” feature or any other seat belt function is not working properly when checked according to the procedures in the Service Manual.
- Failure to replace the belt and retractor assembly could increase the risk of injury in collisions.

Seat Belts and Pregnant Women

We recommend that pregnant women use the seat belts throughout their pregnancy. Keeping the mother safe is the best way to keep the baby safe.

Pregnant women should wear the lap part of the belt across the thighs and as snug across the hips as possible. Keep the belt low so that it does not

come across the abdomen. That way the strong bones of the hips will take the force if there is a collision.

Driver And Front Passenger Supplemental Restraint Systems (SRS) — Airbags

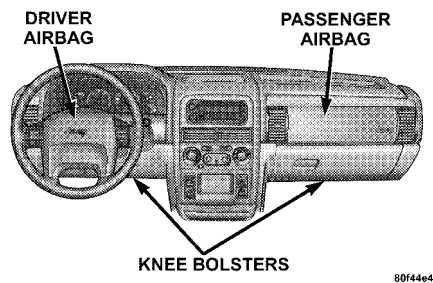

This vehicle has airbags for both the driver and right front passenger as a supplement to the seat belt restraint systems. The driver's front airbag is mounted in the steering wheel. The passenger side airbag is mounted in the instrument panel, above the glove compartment. The words SRS/ AIRBAG are embossed on the airbag covers.

NOTE:

The front airbags are certified to the regulations that allow less forceful deployment.

The front airbags have a multi stage inflator design. This allows the airbag to have different rates of inflation that are based on collision severity.

This vehicle is equipped with window bags to protect the driver, front, and rear passengers sitting next to a window. The window bags are located above the side windows.

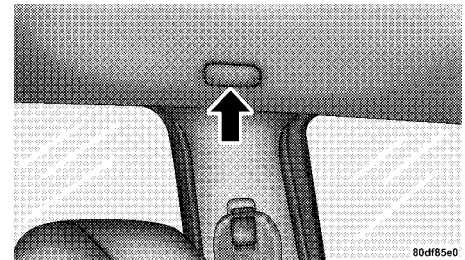

NOTE:

Airbag covers may not be obvious in the interior trim; but they will open to allow airbag deployment.

WARNING!

- Do not put anything on or around the front airbag covers or attempt to manually open them. You may damage the airbags and you could be injured because the airbags are not there to protect you. These protective covers for the airbag cushions are designed to open only when the airbags are inflating.
- Do not stack luggage or other cargo up high enough to block the location of the window bag. The area where the window bag is located should remain free from any obstructions.
- Do not have any accessory items installed which will alter the roof, including adding a sunroof to your vehicle. Do not add roof racks that require permanent attachments (bolts or screws) for installation on the vehicle roof. Do not drill into the roof of the vehicle for any reason.
- Do not cover or place items on the airbag covers. These items may cause serious injury during inflation.

The front airbags have a multi stage inflator design. This allows the airbag to have different rates of inflation that are based on collision severity. Along with the seat belts, front airbags work with

the instrument panel knee bolsters to provide improved protection for the driver and front passenger. Window bags also work with seat belts to improve occupant protection.

The seat belts are designed to protect you in many types of collisions. The front airbags deploy in moderate to severe frontal collisions. But even in collisions where the airbags work, you need the seat belts to keep you in the right position for the airbags to protect you properly.

Here are some simple steps you can take to minimize the risk of harm from a deploying airbag.

1. Children 12 years and under should always ride buckled up in a rear seat.

Infants in rear-facing child restraints should **NEVER** ride in the front seat of a vehicle with a passenger front airbag. An airbag deployment can cause severe injury or death to infants in that position.

If a child from 1 to 12 years old must ride in the front passenger seat because the vehicle is crowded, move the seat as far back as possible, and use the proper child restraint. See "Child Restraint" in this section.

You should read the instructions provided with your child restraint belt-positioning booster seat to make sure that you are using it properly.

2. All occupants should use their lap and shoulder belts properly.

3. The driver and front passenger seats should be moved back as far as practical to allow the airbag room to inflate.

4. Do not lean against the door or window, airbags will inflate forcefully into the space between you and the door.

WARNING!

- Relying on the airbags alone could lead to more severe injuries in a collision. The airbags work with your seat belt to restrain you properly. In some collisions the airbags won't deploy at all. Always wear your seat belts even though you have airbags.
- Being too close to the steering wheel or instrument panel during airbag deployment could cause serious injury. Airbags need room to inflate. Sit back, comfortably extending your arms to reach the steering wheel or instrument panel.
- Window bags need room to inflate. Do not lean against the door or window. Sit upright in the center of the seat.

Airbag System Components

The airbag system consists of the following:

- Airbag Control Module (ACM)
- Airbag Warning Light
- Driver Airbag
- Passenger Airbag
- Window Bags above Side Windows
- Steering Wheel and Column
- Instrument Panel
- Crash Sensor
- Interconnecting Wiring
- Knee Impact Bolsters

How The Airbag System Works

- The **Airbag Control Module (ACM)** determines if a frontal collision is severe enough to require the airbags to inflate. Based on the level of collision severity, the front control module determines the proper rate of inflation. The front airbag inflators are designed to provide different rates of airbag inflation.
- The ACM, along with the remote side impact sensors detects side impact.
- The ACM will not detect roll over, or rear impacts.

- The ACM monitors the readiness of the electronic parts of the system whenever the ignition switch is in the START or ON positions. These include all of the items listed above except the steering wheel and column and the knee bolsters. If the key is in the OFF position, in the ACC position, or not in the ignition, the airbags are not on and will not inflate.

Also, the ACM turns on the AIRBAG warning light in the instrument panel for 6 to 8 seconds when the ignition is first turned on, then turns the light off. If it detects a malfunction in any part of the system, it turns on the light either momentarily or continuously.

WARNING!

Ignoring the AIRBAG warning light in your instrument panel could mean you won't have the airbags to protect you in a collision. If the light does not come on, stays on after you start the vehicle, or if it comes on as you drive, have the airbag system checked right away.

- The **Driver and Passenger Airbag/Inflator Units** are located in the center of the steering wheel and the right side of the instrument panel. When the ACM detects a collision requiring the airbags, it signals the inflator units. A large quantity of nontoxic gas is generated to

inflate the front airbags. Different airbag inflation rates are possible based on collision severity. These rates are determined by the front airbag control module based on collision severity. The steering wheel hub trim cover and the upper right side of the instrument panel separate and fold out of the way as the bags inflate to their full size. The bags fully inflate in about 50–70 milliseconds. This is about half of the time it takes to blink your eyes. The bags then quickly deflate while helping to restrain the driver and front passenger.

The driver front airbag gas is vented through the airbag material towards the instrument panel. The passenger front airbag gas is vented through the airbag material on the sides of the airbag. In this way, the airbags do not interfere with your control of the vehicle.

- The **Knee Impact Bolsters** help protect the knees of the driver and the front passenger's, and position everyone for the best interaction with the front airbag.

If A Deployment Occurs

The airbag system is designed to deploy the airbags when the impact sensors detect a moderate-to-severe frontal collision, to help restrain the driver and front passenger, and then immediately deflate.

NOTE:

A frontal collision that is not severe enough to need airbag protection will not activate the system. This does not mean something is wrong with the airbag system.

If you do have a collision which deploys the airbags, any or all of the following may occur:

- The nylon airbag material may sometimes cause abrasions and/or skin reddening to the driver and front passenger as the airbags deploy and unfold. The abrasions are similar to friction rope burns or those you might get sliding along a carpet or gymnasium floor. They are not caused by contact with chemicals. They are not permanent and normally heal quickly. However, if you haven't healed significantly within a few days, or if you have any blistering, see your doctor immediately.
- As the airbags deflate you may see some smoke-like particles. The particles are a normal by-product of the process that generates the nontoxic gas used for airbag inflation. These airborne particles may irritate the skin, eyes, nose, or throat. If you have skin or eye irritation, rinse the area with cool water. For nose or throat irritation, move to fresh air. If the irritation continues, see your doctor. If these particles settle on your clothing, follow the garment manufacturer's instructions for cleaning.

- It is not advisable to drive your vehicle after the airbags have deployed. If you are involved in another collision, the airbags will not be in place to protect you.

WARNING!

Deployed airbags can't protect you in another collision. Have the airbags replaced by an authorized dealer as soon as possible.

The side impact SRS airbags are designed to activate only in certain side collisions. When the ACM in conjunction with remote side impact sensors detects a side impact collision requiring the window bags to inflate, it signals the inflators on the crash side of the vehicle. A quantity of nontoxic gas is generated to inflate the window bag. The inflating window bag pushes the outside edge of the headliner out of the way and covers the window. The airbag inflates in about 30 milliseconds (about one quarter of the time it takes to blink your eyes) with enough force to injure you if you are not belted and seated properly, or if items are positioned in the area where the window bag inflates. This especially applies to children. The window bag is only about 9 cm (3½ inches) thick when it is inflated.

Maintaining Your Airbag System

WARNING!

- Modifications to any part of the airbag system could cause it to fail when you need it. You could be injured if the airbag system is not there to protect you. Do not modify the components or wiring, including adding any kind of badges or stickers to the steering wheel hub trim cover or the upper right side of the instrument panel. Do not modify the front bumper or vehicle body structure.
- You need proper knee impact protection in a collision. Do not mount or locate any aftermarket equipment on or behind the knee bolsters.
- It is dangerous to try to repair any part of the airbag system yourself. Be sure to tell anyone who works on your vehicle that it has an airbag system.

Airbag Warning Light

You will want to have the airbag system ready to inflate for your protection in an impact. The airbag system is designed to be maintenance free. If any of the following occurs, have an authorized dealer service the system promptly:

- Does not come on during the 6 to 8 seconds after the ignition switch is first turned on.
- Remains on after the 6 to 8 second interval.
- Comes on for any period of time while driving.

Child Restraint

Everyone in your vehicle needs to be buckled up all the time — babies and children, too.

WARNING!

“Extreme Hazard! Do not use a rearward facing child restraint on a seat protected by an airbag in front of it!” Refer to visor mounted labels for information.

WARNING!

In a collision, an unrestrained child, even a tiny baby, can become a missile inside the vehicle. The force required to hold even an infant on your lap can become so great that you could not hold the child, no matter how strong you are. The child and others could be badly injured. Any child riding in your vehicle should be in a proper restraint for the child’s size.

Mass Group	Seating Position		
	Front Passenger	Rear Outboard	Rear Center
0 - Up to 10 kg (0-9 months)	X	U	U
0+ - Up to 13 kg (0-2 years)	X	U	U
1 - 9 to 18 kg (9 months - 4 years)	X	U	U
II & III - 15 to 36 kg (4 - 12 years)	X	U	U

Key of letters used in the table above:

U = Suitable for “universal” category restraints approved for use in this age/weight group.

UF = Suitable for forward-facing “universal” category restraints approved for use in this age/weight group.

L = Suitable for particular child restraints given on attached list. These restraints may be of the “specific vehicle”, “restricted” or “semi-universal” categories.

B = Built-in restraint approved for the age/weight group.

X = Seat position not suitable for children in this age/weight group.

Infants and Small Children

There are different sizes and types of restraints for children from newborn size to the child almost large enough for the adult seat belt. Always check the child seat owner’s manual to ensure you have the right seat for your child. Use the restraint that is correct for your child:

- The rearward-facing infant restraint is for babies weighing up to about 9 kg. (20 lbs.), and less than one year old. The infant restraint must **NEVER** be used in the front seat of a vehicle with a passenger side airbag. An airbag deployment could cause severe injury or death to infants in this position. The infant restraint is held in the vehicle by the lap belt or lap/shoulder belt.

- Children under one year of age should continue to ride in a rear-facing infant seat, even if they weigh more than 9 kg. (20 lbs.). A “convertible” child seat, one that is designed to be used either rearward-facing or forward-facing, should be used for children who are too heavy for the infant carrier, but who are too young to face forward in the vehicle.
- The forward-facing child seat is for children from about 9 kg. to 18 kg. (20 lbs. to 40 lbs.), and at more than one year old. The child seat is held in the vehicle by the lap belt or lap/shoulder belt.
- The belt-positioning booster seat is for children weighing more than 18 kg. (40 lbs.). The child and booster seat are held in the vehicle by the lap/shoulder belt. (Some booster seats are equipped with a front shield and are held in the vehicle by the lap portion or lap belt.)

WARNING!

Improper installation can lead to failure of an infant or child restraint. It could come loose in a collision. The child could be badly injured or killed. Follow the manufacturer’s directions exactly when installing an infant or child restraint.

Here are some tips for getting the most out of your child restraint:

- Before buying any restraint system, make sure that it has a label certifying that it meets applicable Safety Standards. Also, the manufacturer recommends that you try a child restraint in the vehicle seats where you will use it before you buy it.
- The restraint must be appropriate for your child’s weight and height. Check the label on the restraint for weight and height limits.
- Carefully follow the instructions that come with the restraint. If you install the restraint improperly it may not work when you need it.
- The passenger seat belts are equipped with cinching latch plates which are designed to keep the lap portion or lap belt tight around the child restraint so that it is not necessary to use a locking clip. Pulling up on the shoulder portion of the lap/shoulder belt will tighten the belt. The cinching latch plate will keep the belt tight, however, any seat belt system will loosen with time, so check the belt occasionally and pull it tight if necessary.
- In the rear seat, you may have trouble tightening the lap/shoulder belt on the child restraint because the buckle or latch plate is too close to the belt path opening on the restraint. Discon-

nect the latch plate from the buckle and twist the short buckle-end of the belt several times to shorten it. Insert the latch plate into the buckle with the release button facing out.

- If the belt still cannot be tightened, or if pulling and pushing on the restraint loosens the belt, disconnect the latch plate from the buckle, turn the buckle around, and insert the latch plate into the buckle again. If you still cannot make the child restraint secure, try a different seating position.
- Buckle the child into the seat according to the child restraint manufacturer’s directions.
- When your child restraint is not in use, secure it with the seat belt or remove it from the vehicle. Do not leave it loose in the vehicle. In a sudden stop or collision, it could strike the occupants or seat backs and cause personal injury.

Child Restraint Tether Anchor

Child restraints having tether straps and hooks for connection to tether anchors have been available for some time. In fact, many child restraint manufacturers will provide add-on tether strap kits for certain of their older products.

To attach a child restraint tether strap hook, route the tether strap underneath the headrest where you are placing the child seat and secure the tether strap hook to the anchor loop in the rear

seatback. Install the child restraint according to the manufacturers instructions, and tighten the vehicle seat belt. Remove the slack from the tether strap according to the manufacturers instructions.

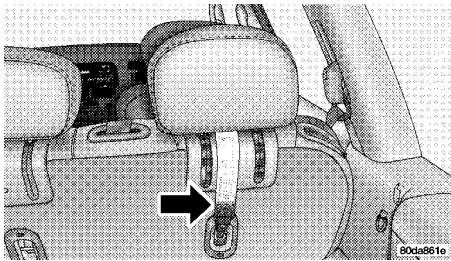

WARNING!

An incorrectly anchored tether strap could lead to increased head motion and possible injury to the child. Use only the anchor positions directly behind the child seat to secure a child restraint top tether strap.

Children Too Large for Booster Seats

Children who are large enough to wear the shoulder belt comfortably, and whose legs are long enough to bend over the front of the seat when

their back is against the seat back should use the lap/shoulder belt in a rear seat.

- Make sure that the child is upright in the seat.
- The lap portion should be low on the hips and as snug as possible.
- Check belt fit periodically. A child's squirming or slouching can move the belt out of position.

If the shoulder belt contacts the face or neck, move the child closer to the center of the vehicle. If this doesn't help, move the child to the center rear seating position and use the lap belt. Never allow a child to put the shoulder belt under an arm.

ENGINE BREAK-IN RECOMMENDATIONS

To provide the longest engine life, follow these guidelines for the first few hundred kilometers (or miles).

- Check the fluid and engine oil levels regularly and be alert for indications of overheating in any component of the vehicle. Engines tend to use more fuel and oil until they are broken in, so don't expect top economy for the first 1 931 km (1,200 miles).
- After starting a cold engine, let it warm up for 15 seconds or so before shifting into gear.

- Allow proper break-in, at least 1 931 km (1,200 miles), before requesting engine adjustments, if then needed.
- Drive at varying speeds below 80 km/h (50 mph) for first 160 km (100 miles) and below 88 km/h (55 mph) for first 800 km (500 miles). Avoid driving at full throttle or top speeds, steady speeds, or excessive idling during this period. Avoid fast starts and quick stops.
- A break-in oil is not used. The original engine oil is the same type specified for regular oil changes. There is no need to have it changed or the oil filter replaced until the first scheduled maintenance interval except in heavy-duty operation. Don't add anti-friction compounds or special break-in oils during the first few thousand kilometers (or miles) of operation, since these additives might interfere with proper piston ring seating.

NOTE:

Maintaining proper fluid levels is particularly important during the break-in period. Refer to "Maintenance Procedures" in Section 7 for checking fluid levels.

SAFETY TIPS

Exhaust Gas

WARNING!

Exhaust gases can injure or kill. They contain carbon monoxide (CO) which is colorless and odorless. Breathing it can make you unconscious and can eventually poison you. To avoid breathing (CO) follow the safety tips below.

- Do not inhale exhaust gases. They contain carbon monoxide, a colorless and odorless gas which can kill. Never run the engine in a closed area, such as a garage, and never sit in a parked vehicle with the engine running for an extended period. If the vehicle is stopped in an open area with engine running for more than a short period, adjust the ventilation system to force fresh, outside air into the vehicle.
- Guard against carbon monoxide with proper maintenance. Have the exhaust system inspected every time the vehicle is raised. Have any abnormal conditions repaired promptly. Until repaired, drive with all side windows fully open.
- Always run the climate control in panel or floor mode when driving with any windows open, even if only slightly, to help keep fresh air circulating inside vehicle. Otherwise poisonous gases could be drawn into the vehicle.

Safety Checks You Should Make Inside The Vehicle

Seat Belts

Inspect the belt system periodically, checking for cuts, frays and loose parts. Damaged parts must be replaced immediately. Do not disassemble or modify the system.

Seat belt assemblies must be replaced after an accident if they have been damaged (bent retractor, torn webbing, etc.). If there is any question regarding belt or retractor condition, replace the belt.

Airbag Warning Light

The light should come on and remain on for 6 to 8 seconds as a bulb check when the ignition switch is first turned on. If the bulb is not lit during starting, have it replaced. If the light stays on or comes on while driving, have the system checked by an authorized dealer.

Defrosters

Check operation by selecting the defrost mode and place the blower control on high speed. You should feel the air directed against the windshield.

Safety Checks You Should Make Outside The Vehicle

Tires

Examine tires for excessive tread wear or uneven wear patterns. Check for stones, nails, glass, or other objects lodged in the tread. Inspect for tread cuts or sidewall cracks. Check wheel nuts for tightness and tires (including spare) for proper pressure.

Lights

Have someone observe the operation of all exterior lights while you work the controls. Check turn signal and high beam indicator lights on the instrument panel.

Fluid Leaks

Check area under vehicle after overnight parking for fuel, coolant, oil or other fluid leaks. Also, if gasoline fumes are detected, the cause should be located and corrected immediately.

UNDERSTANDING THE FEATURES OF YOUR VEHICLE

• MIRRORS	30
• Inside Day/Night Mirror	30
• Inside Automatic Dimming Mirror — If Equipped	30
• Exterior Mirrors Folding Feature	30
• Outside Mirrors	30
• Heated Remote Control Mirrors — If Equipped	31
• Power Remote Control Outside Mirrors	31
• Power Folding Outside Mirrors — If Equipped	31
• Lighted Vanity Mirrors — If Equipped	31
• SEATS	31
• Front Seat Adjustment (Recline)	32
• Head Restraints	32
• Power Seat Adjuster	33
• Memory System — If Equipped	34
• Heated Seats — If Equipped	35
• 60/40 Split Rear Seat	35
• TO OPEN AND CLOSE THE HOOD	36
• LIGHTS	36

- Interior Lighting 36
- Front Map/Reading Lights 36
- Multi-Function Control Lever 37
- Battery Saver Feature (Exterior Lights) 37
- Headlights, Position Lights, and Instrument Panel Lights 37
 - Lights-On Reminder 37
 - Front Fog Lights — If Equipped 37
 - Rear Fog Lights 38
 - Turn Signals 38
 - Headlight Dimmer Switch 38
 - Passing Light 38
 - Headlamp Leveling System — If Equipped 38
 - Headlight Time Delay 38
- WINDSHIELD WIPERS AND WASHERS 39
 - Mist 39
 - Speed Sensitive Intermittent Wiper System 39
 - Rain Sensitive Wiper System — If Equipped 39
- TILT STEERING COLUMN 40
- ELECTRONIC SPEED CONTROL 40
 - To Activate 41
 - To Set at a Desired Speed 41
 - To Deactivate 41
 - To Resume Speed 41
 - To Vary the Speed Setting 41

- To Accelerate for Passing 41
- Driving Up or Down Hills 41
- OVERHEAD CONSOLE — IF EQUIPPED 42
 - Dome/Reading Lights 42
 - Electronic Vehicle Information Center 42
 - Customer Programmable Features 43
 - Compass/Temperature/Trip Computer 44
 - Trip Computer 44
- POWER SUNROOF — IF EQUIPPED 47
 - Express Open Mode 47
 - Manual Open Mode 47
 - Closing Operation 47
 - Vent Operation 47
 - Ignition Off Operation 48
 - Sunshade Operation 48
 - Maintenance 48
- POWER OUTLET 48
- GLOVE COMPARTMENT 49
- CUP HOLDERS 49
- CARGO AREA FEATURES 49
 - Cargo Light 49
 - Retractable Cargo Area Cover — If Equipped 50
 - Cargo Tie-Down Hooks 50
- ROOF LUGGAGE RACK 51

MIRRORS

Inside Day/Night Mirror

The mirror should be adjusted to center on the view through the rear window. A two-point pivot system allows for horizontal and vertical adjustment of the mirror. The mirror should be adjusted while set in the day position (toward windshield).

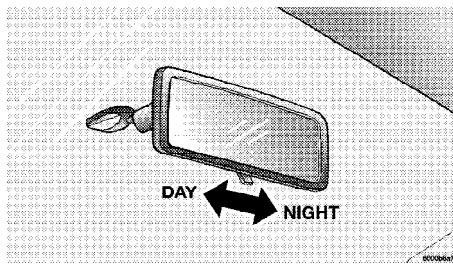

Annoying headlight glare from vehicles behind you can be reduced by moving the small control under the mirror to the night position (toward rear of vehicle).

Inside Automatic Dimming Mirror — If Equipped

This mirror automatically adjusts for annoying headlight glare from vehicles behind you. You can turn the feature on or off by pressing the button at

the base of the mirror. A light next to the button will indicate when the dimming feature is activated.

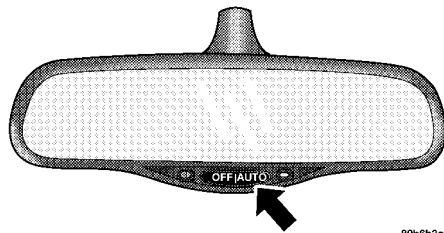

CAUTION!

To avoid damage to the mirror during cleaning, never spray any cleaning solution directly onto the mirror. Apply the solution onto a clean cloth and wipe the mirror clean.

Driver's Outside Automatic Dimming Mirror — If Equipped

The driver's outside automatic dimming mirror operates when the inside automatic dimming mirror is on. This outside mirror operates off the inside mirror switch and will automatically adjust for annoying headlight glare when the inside mirror does.

NOTE:

The passenger outside mirror does not have this dimming feature.

Exterior Mirrors Folding Feature

All exterior mirrors are hinged and may be moved either forward or rearward to resist damage. The hinges have three detent positions; full forward, full rearward, and normal.

Outside Mirrors

To receive maximum benefit, adjust the outside mirrors to center on the adjacent lane of traffic with a slight overlap of the view obtained on the inside mirror.

WARNING!

Vehicles and other objects seen in the right side convex mirror will look smaller and farther away than they really are. Relying too much on your right side mirror could cause you to collide with another vehicle or other objects. Use your inside mirror when judging the size or distance of a vehicle seen in the right side mirror.

Heated Remote Control Mirrors — If Equipped



These mirrors are heated to melt frost or ice. This feature is activated whenever you turn on the Rear Window Defrost.

Power Remote Control Outside Mirrors

The controls for the power mirrors are located on the driver's door trim panel above the window switches.

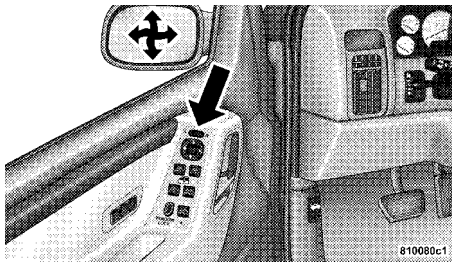

Set the top switch to the left or right for the left or right mirror, and set it to the center off position to prevent accidentally moving a mirror when you are finished adjusting the mirror. To adjust a mirror, select left or right with the top switch, and press one of the four arrows for the direction you want the mirror to move.

Power Folding Outside Mirrors — If Equipped

The controls for the power folding mirrors are located in the center of the power mirror switch.

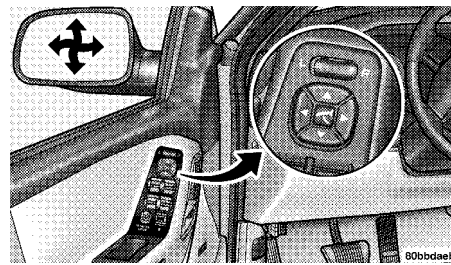

Press the switch once and the mirrors will fold in, press the switch a second time and the mirrors will return to the normal driving position (unfolded).

Both mirrors always move together and will fold anytime the switch is pressed. The ignition switch does not have to be in the ON position.

Lighted Vanity Mirrors — If Equipped

To access a lighted vanity mirror, flip down one of the visors.

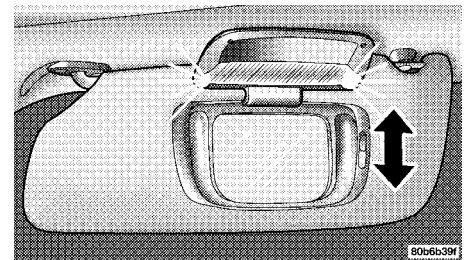

Lift the cover to reveal the mirror. The light will turn on automatically. Sliding the button up or down will vary the intensity of the light.

SEATS

WARNING!

Adjusting a seat while the vehicle is moving is dangerous. The sudden movement of the seat could cause you to lose control. The seat belt might not be properly adjusted and you could be injured. Adjust any seat only while the vehicle is parked.

Front Seat Adjustment (Recline)

To adjust the seatback, lift the lever located on the outboard side of the seat, lean back, and release the lever at the desired position. To return the seatback, lift the lever, lean forward, and release the lever.

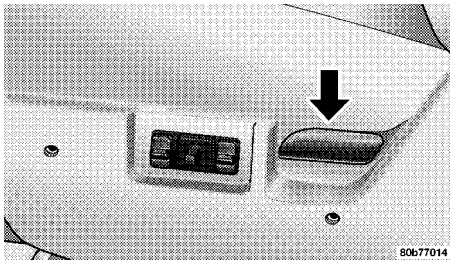

WARNING!

Do not ride with the seatback reclined so that the seat belt is no longer resting against your chest. In a collision you could slide under the seat belt and be seriously or even fatally injured. Use the recliner only when the vehicle is parked.

WARNING!

It is extremely dangerous to ride in a cargo area, inside or outside of a vehicle. In a collision, people riding in these areas are more likely to be seriously injured or killed.

Do not allow people to ride in any area of your vehicle that is not equipped with seats and seat belts.

Be sure everyone in your vehicle is in a seat and using a seat belt properly.

Head Restraints

Head restraints can reduce the risk of whiplash injury in the event of impact from the rear. Adjustable head restraints should be adjusted so that the upper edge is as high as practical.

NOTE:

The rear seat headrests are not adjustable but can be rotated into a stowage position by pressing the rear seat back release handle. They can be returned to a usable position by manually rotating forward until they lock.

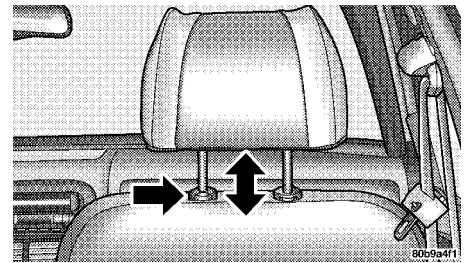

The head restraints have a locking button that must be pushed in to lower the head restraint to all positions, except the full-down position. To lower the head restraint to the full-down position, the button does not have to be pushed in.

The restraints may be raised without pushing in the button.

Power Seat Adjuster

WARNING!

Do not ride with the seatback reclined so that the shoulder belt is no longer resting against your chest. In a collision you could slide under the seat belt and be seriously injured or even fatally injured. Use the recliner only when the vehicle is parked.

6-Way Power Seat with Manual Recliner — If Equipped

This seat switch is on the outboard side of the seat near the floor. Use this switch to move the seat up or down, forward or rearward, or to tilt the seat.

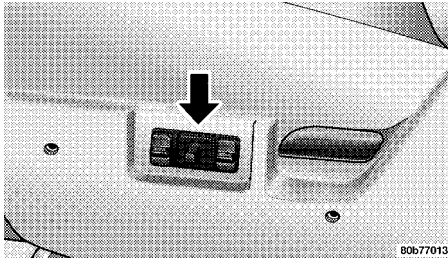

This seat also has a manual recline lever located just to the rear of the power seat switch. Pull up on the lever to recline the seat.

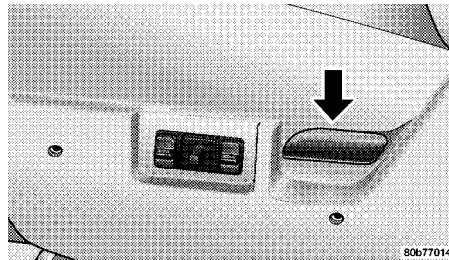

10-Way Power Seat with Power Recliner and Power Lumbar — If Equipped

These seat switches are located on the outboard side of the seat near the floor. Use these switches to move the seat up or down, forward or rearward, to tilt the seat, to recline the seat, or to increase/decrease the amount of lumbar support.

CAUTION!

Don't put anything under a power seat. It may cause damage to the seat controls.

Power Lumbar

The power lumbar control is located on the outboard side of the seat. Use this switch to increase or decrease the desired amount of lumbar support.

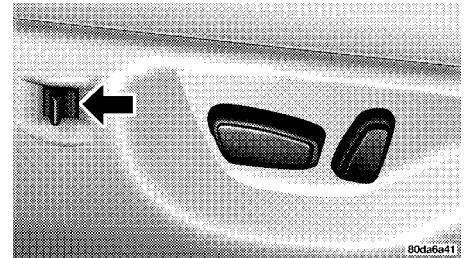

Power Reclining Seat

The recliner control is on the outboard side of the seat. Use this switch to recline the seatback and to return the seatback to the upright position.

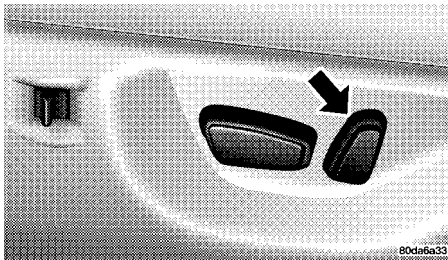

WARNING!

Do not ride with the seatback reclined so that the seat belt is no longer resting against your chest. In a collision you could slide under the seat belt and be seriously or even fatally injured. Use the recliner only when the vehicle is parked.

Memory System — If Equipped

If your vehicle is equipped with this system, your Remote Keyless Entry Transmitter or Memory System buttons on the driver's door panel can be

used to recall the driver's seat and outside mirror, and radio station presets to saved positions.

The Memory System buttons located on the driver's door will always recall stored settings. The Remote Keyless Entry Transmitters can be programmed to recall positions when the "Unlock" button is pressed. For customer programmable features refer to the section on "Overhead Console" for programming details, otherwise see your authorized dealer.

NOTE:

The vehicle must be in P (Park) and the seat belt cannot be latched to recall memory positions.

Your vehicle was delivered to you with two remote keyless entry transmitters. They are color coded to match the memory buttons on the driver's door. These transmitters work in conjunction with the number "1" (black) and number "2" (gray) memory seat buttons on the driver's door. Once the memory button has been set, the corresponding remote keyless entry transmitter is also set.

NOTE:

If the memory system is not set to your desired positions, the driver's seat and mirror will default to the factory setting each time the Keyless Entry Transmitter is used.

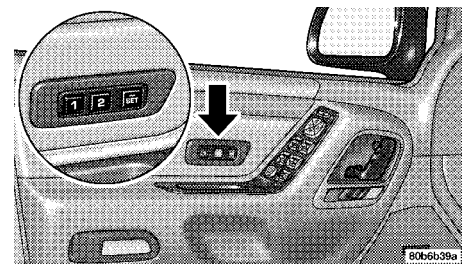

To set the memory buttons follow this procedure:

1. Turn the ignition key to the ON position.
2. Press the memory button number "1" if you are setting the memory for driver one or number "2" if you are setting the memory for driver two.
3. Adjust the seat, recliner, and driver's outside rearview mirror to the desired position.
4. Set the radio station presets as you desire (up to 10 AM and 10 FM station settings).
5. Press and release the SET button. An indicator light on the set switch will flash, telling you that you are in the set memory mode.
6. Press and release button number "1" or number "2" on the driver's door, depending on which transmitter you're using. The flashing indicator

light on the set switch will go out telling you that the driver memory has been set.

If your remote keyless entry transmitter is lost, you may order a new transmitter from your local authorized dealer. You must designate transmitter #1 or #2. Your authorized dealer will have to program your vehicle to match the new transmitter.

Heated Seats — If Equipped

This feature heats the driver's and passenger's front seats. The controls for the heated seats are located on the instrument panel near the ash tray.

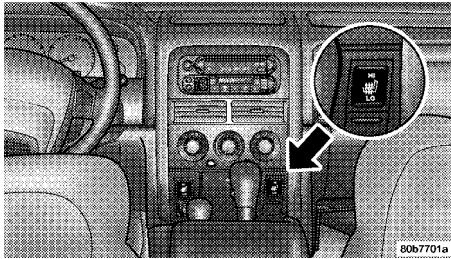

After turning on the ignition switch you can choose from HI, OFF, or LO heat settings. An indicator light on the switch shows which setting has been selected. To turn off the heated seats, position the switch in the middle.

60/40 Split Rear Seat

Either side of the rear seat can be folded flat to allow for extended cargo space and still maintain some rear seating room.

NOTE:

Be sure that the front seats are fully upright and positioned forward. This will allow the rear seatback to fold down easily.

To fold the 60/40 rear seat perform the following steps:

1. Use the pull straps available on each seat cushion section; pull the strap and pivot the cushion forward flush with the front seatback.

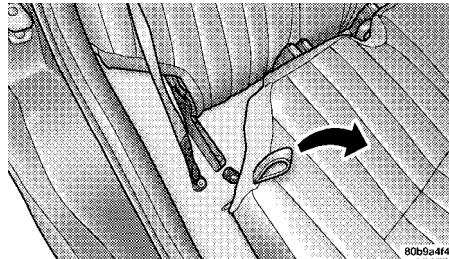

2. Locate the seatback release handle on the outboard side of each rear seatback; push upward on the handle until the headrests drop and the seatback releases.

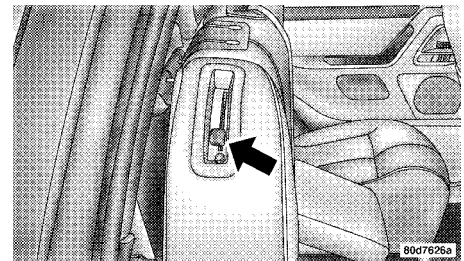

3. Fold the seatback completely forward. When the seatback is folded completely forward, the seatback should be folded flat.

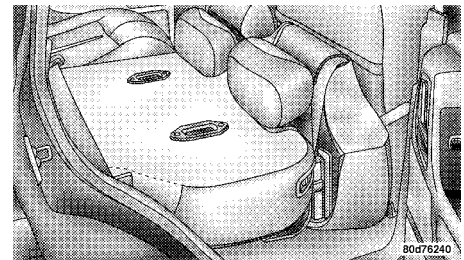

To restore the 60/40 rear seat to the upright position perform the following steps:

Raise the rear seatback, headrests, and lock seatback it into place. If interference from the cargo area prevents the seatback from fully locking, you will have difficulty returning the seat cushion to its proper position.

WARNING!

Be certain that the seatback is securely locked into position. If the seatback is not securely locked into position the seat will not provide the proper stability for child seats and/or passengers. An improperly latched seat could cause serious injury.

Rotate the seat cushion rearward until it is latched into place.

TO OPEN AND CLOSE THE HOOD

To open the hood, pull the release lever inside your vehicle located below the instrument panel and in front of the driver's door.

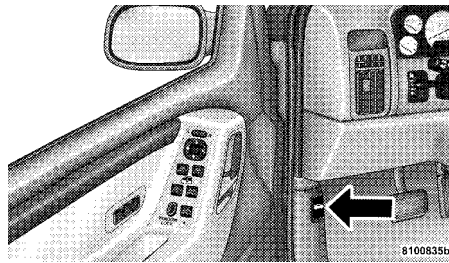

Then reach under the hood and pull upward on the safety latch and lift the hood.

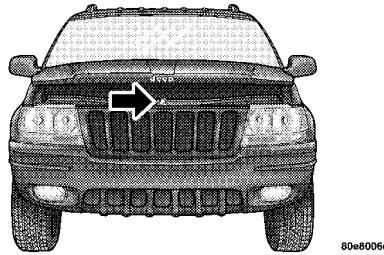

To prevent possible damage, do not slam the hood to close it. Use a firm downward push at the center of the hood to ensure that both latches engage.

WARNING!

If the hood is not fully latched, it could fly up when the vehicle is moving and block your forward vision. Be sure all hood latches are fully latched before driving.

LIGHTS

Interior Lighting

The interior lighting consists of courtesy lamps mounted below the instrument panel, an overhead console light assembly which contains both driver and passenger reading lights, reading lights located above the rear doors, and a rear cargo light. Opening a door or turning the center of the multi-function control lever to the extreme up position will activate all interior courtesy lights.

Front Map/Reading Lights

These lights are mounted in the overhead console. Each light can be turned on by pressing the recessed area of the lens. To turn these lights off press the recessed area of the lens a second time. Also, there are reading lights located above the rear doors. Each light can be turned on by pressing the front recessed area of the lens. To turn these lights off press the recessed area of the lens a second time.

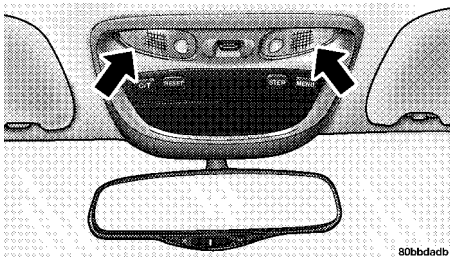

Multi-Function Control Lever

The multi-function control lever controls the operation of the headlights, position lights, turn signals, headlight beam selection, instrument panel light dimming, passing light, interior courtesy lights, front fog lights and rear fog lights.

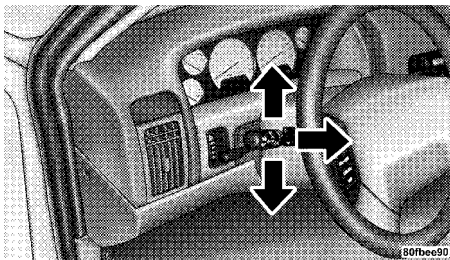

Battery Saver Feature (Exterior Lights)

If the multi-function control lever is in the headlight or rear fog light position when the ignition switch is moved to the OFF position, the exterior lights will automatically turn off after 8 minutes. If the multi-function control lever is in the front position light mode, the front position lights will remain on until the lever is moved to a different position. Normal operation will resume when the ignition is turned ON or when the headlight switch is turned to another position.

Headlights, Position Lights, and Instrument Panel Lights

Turn the end of the multi-function control lever to the first detent for front and rear position light operation. Turn to the second detent for headlight operation. Turn to the third detent for AUTO headlight operation (if equipped).

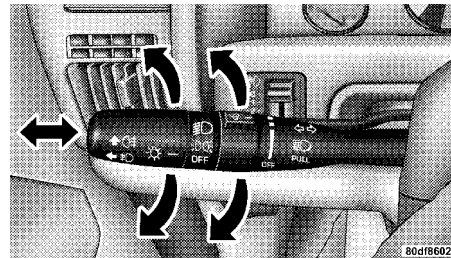

To change the brightness of the instrument panel lights, turn the center portion of the multi-function control lever up or down.

Lights-On Reminder

If the headlights or position lights are on after the ignition switch is turned OFF, a chime will sound when the driver's door is opened.

Front Fog Lights — If Equipped



The front fog light switch is in the multi-function control lever. To activate the front fog lights, turn the multi-function control lever to the first detent position and pull out the end of the control lever.

A light in the instrument cluster shows when the front fog lights are on.

NOTE:

The switch will turn on the front fog lights if the position lights, low beam headlights, high beam headlights or rear fog lights are on.

A front fog light is a lighting device that provides illumination in front of the vehicle under conditions of fog, rain, snow, or dust. Principally, the front fog light supplements the lower beam of a standard headlight system.

NOTE:

Proper aim and adjustment of the front fog lights should be made to prevent excessive glare for other drivers.

Rear Fog Lights

 The rear fog light switch is in the multi-function control lever. To activate the rear fog lights, rotate the multi-function control lever to the first or second detent position, pull out the end of the multi-function control lever, and then rotate to the third detent position. A light in the instrument cluster shows when the rear fog lights are on.

Turn Signals

Move the multi-function control lever up or down and the arrows on each side of the instrument cluster flash to show proper operation of the front and rear turn signal lights. You can signal a lane change by moving the lever partially up or down.

Headlight Dimmer Switch

Pull the multi-function control lever towards you to switch the headlights to HIGH beam. Pull the multi-function control lever a second time to switch the headlights to LOW beam.

Passing Light

You can signal another vehicle with your headlights by lightly pulling the multi-function control lever toward the steering wheel. This will cause the headlights to turn on at high beam and remain on until the lever is released.

Headlamp Leveling System — If Equipped

Your vehicle may be equipped with a headlamp leveling system. The headlamp leveling system allows the driver to maintain proper headlight beam position with the road surface regardless of vehicle load. The switch is located on the instrument panel to the left of the steering column.

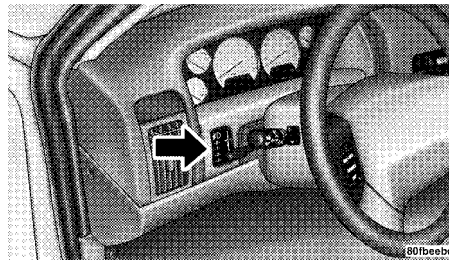

To operate: Slide the control switch until the appropriate number, which corresponds to the load listed on the chart below, aligns with the indicator line on the switch. A higher number results in a lower headlight beam relationship to the road surface.

NUMBER OF PERSONS	FRONT	1	2	2	2	1
	REAR			3	3	
ADDITIONAL LOAD IN CARGO AREA					MAX *	MAX *
SWITCH POSITION		0	0	1	2	3

Calculations based on weight of 75 kg (165 lbs) per person.

* The total weight of persons listed plus an evenly distributed load in the cargo area equals the maximum load capacity of the vehicle.

NOTE:

When towing a trailer, add one number to the switch position listed on the chart for the appropriate vehicle load condition.

Headlight Time Delay

There is also a feature that delays turning off the headlights for 30, 60 or 90 seconds after the ignition switch is turned OFF. To activate the headlight delay, the multi-function control lever must be rotated to the OFF position after the ignition switch is turned OFF. Only the headlights will illuminate during this time. See the information about the overhead console to turn this feature ON/OFF or set the time interval.

WINDSHIELD WIPERS AND WASHERS

The front and rear wipers and washers are operated by a switch in the right side control lever. Turn the end of the control lever to select "Lo," "Hi," or one of the five speed sensitive intermittent windshield wiper speeds. Refer to "Speed Sensitive Intermittent Wiper System" in this section. For information on the rear wiper and washer refer to "Rear Window Features" in Section 4 of this manual.

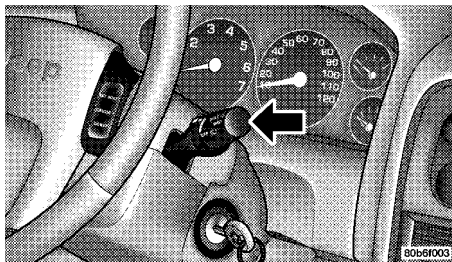

NOTE:

Always remove any build-up of snow that prevents the windshield wiper blades from returning to the OFF position. If the windshield wiper switch is turned off and the blades cannot return to the OFF position, damage to the wiper motor may occur.

To use the washer, pull the lever toward you and hold while spray is desired. If the lever is pulled while in the delay range, the wiper will operate for several seconds after the lever is released, and then resume the intermittent interval previously selected.

If the lever is pulled while in the OFF position, the wipers will operate for several wipe cycles, then turn off.

WARNING!

Sudden loss of visibility through the windshield could lead to an accident. You might not see other vehicles or other obstacles. To avoid sudden icing of the windshield during freezing weather, warm the windshield with the defroster before and during windshield washer use.

Mist

Use this feature when weather conditions make occasional usage of the wipers necessary. Pull down and release the control lever for a single wiping cycle.

Speed Sensitive Intermittent Wiper System

Use one of the five intermittent wiper speeds when weather conditions make a single wiping cycle, with a variable pause between cycles, desirable.

Turn the end of the lever to one of the five delay positions for the desired delay interval. The delay can be regulated from a maximum of approximately 18 seconds between cycles, to a cycle every 1/2 second.

NOTE:

The wiper delay times depend on vehicle speed. If the vehicle is moving less than 16 km/h (10 mph), delay times will be doubled.

Rain Sensitive Wiper System — If Equipped

The rain sensitive wiper system provides you with the convenience of automatically detecting moisture on your windshield and turning on the wipers at the appropriate speed. The Rain Sensor is located above the rear view mirror and reacts to any moisture present in the area of the sensor.

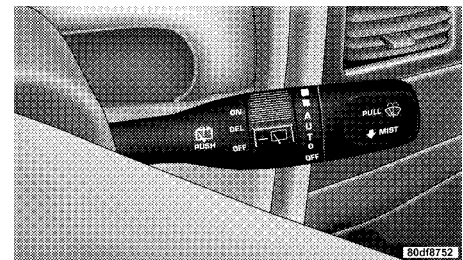

To activate the rain sensitive wiper system, turn the front wiper control lever to AUTO. When you turn the lever to AUTO, the wipers will operate a single wipe cycle. The wipers will also cycle once when you start the vehicle if the lever was left in AUTO.

There are five AUTO positions on the lever to allow you to select system sensitivity that best suits you. The lowest position (closest to OFF) is the least sensitive to rain and the highest position is the most sensitive. If you select a low sensitivity position on the control lever, the system will be slower to react to rain and wipe only after some rain accumulates on the windshield. If you select a high sensitivity position, the system will be very quick to react to rain drops and will wipe more often. If it is raining steadily, the wipers will wipe continuously regardless of what sensitivity the lever is. If the rain is heavy, the wipers will operate in high speed. Every time you move the lever to a higher sensitivity, the wipers will immediately operate a single wipe cycle.

NOTE:

Since the rain sensor is designed to detect moisture, road spray, smashed bugs, and moisture from passing trucks may occasionally cause the wipers to cycle if the lever is in AUTO. Also, manual intervention may be necessary under certain conditions: Additional

wipes may be desired, in foggy/misty mornings, where condensation builds up very slowly on the windshield, or when water accumulated on the roof of the vehicle runs down the windshield, but not over the sensor.

Fewer wipes and/or washer fluid may be desired when salty road spray is encountered, where the operator may want to turn the "Auto" feature off and use the "Wash" and/or "Mist" functions.

CAUTION!

Turn the wiper lever to the OFF position to avoid wiper damage when driving through an automatic car wash.

WARNING!

Turn the wiper lever to the OFF position when cleaning your windshield to avoid injury.

TILT STEERING COLUMN

To tilt the column, pull the small lever, located behind the turn signal control, toward you and move the wheel up or down, as desired. Release the lever to lock the wheel firmly in place.

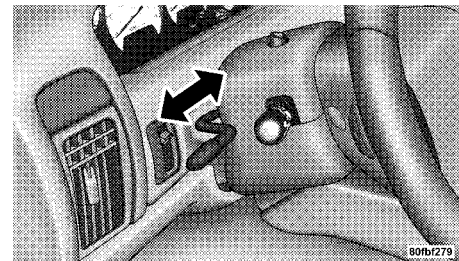

WARNING!

Tilting the steering wheel column while the vehicle is moving is dangerous. Without a stable steering column, you could lose control of the vehicle and have an accident. Adjust the tilting mechanism only while the vehicle is stopped. Be sure it is locked before driving.

ELECTRONIC SPEED CONTROL

When engaged, this device takes over accelerator operations at speeds greater than 60 km/h (40 mph). The controls are mounted on the steering wheel and consist of ON-OFF, SET, RES-ACCEL, CANCEL, and COAST controls.

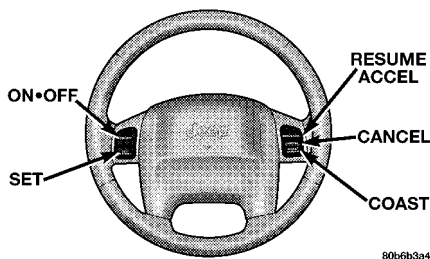

To Activate

Press the ON-OFF button to turn the system ON. To turn the system OFF, press the ON-OFF button again. The system should be turned OFF when not in use. The CRUISE indicator light in the instrument cluster will illuminate when the system is ON.

To Set at a Desired Speed

When the vehicle has reached the desired speed, press and release the SET button. Release the accelerator and the vehicle will operate at the selected speed.

To Deactivate

A soft tap on the brake pedal, normal braking, or pressing the CANCEL button will deactivate the Speed Control without erasing the memory. Press-

ing the ON-OFF to turn the system OFF or turning off the ignition erases the memory.

To Resume Speed

To resume a previously set speed, press and release the RES-ACCEL button. Resume can be used at any speed above 48 km/h (30 mph).

To Vary the Speed Setting

When the Speed Control is ON, speed can be increased by pressing and holding the RES-ACCEL button. When the button is released, a new set speed will be established.

Tapping the RES-ACCEL button once will result in a 3 km/h (2 mph) speed increase. Each time the button is tapped, speed increases, so tapping the button three times will increase speed by 10 km/h (6 mph), etc.

To decrease speed while Speed Control is ON and SET, press and hold the COAST button. Release the button when the desired speed is reached, and the new speed will be set.

To Accelerate for Passing

Depress the accelerator as you would normally. When the pedal is released, the vehicle will return to the set speed.

NOTE:

When driving uphill, at elevations above 610 meters (2,000 feet), or when the vehicle is

heavily loaded (especially when towing) the vehicle may slow below the SET speed. If the vehicle speed drops below 48 km/h (30 mph), the Speed Control will automatically disengage. If this happens, you can push down on the accelerator pedal to maintain the desired speed.

Vehicles may exhibit several 4-3 downshifts under the above conditions. To reduce the frequency of the downshifts and to improve vehicle performance, it is advisable to lock out overdrive. Press the O/D OFF button on the side of the shift lever.

WARNING!

Leaving the Speed Control ON when not in use is dangerous. You could accidentally set the system or cause it to go faster than you want. You could lose control and have an accident. Always leave the system OFF when you aren't using it.

Driving Up or Down Hills

When going up or down hills, it is possible for your vehicle to lose or gain speed, even though the Speed Control is engaged. If going down a hill steep enough to cause the vehicle to gain speed, press the brake pedal, which will disengage the Speed Control and help slow your vehicle.

WARNING!

To help keep your vehicle under control, do not use Speed Control under these conditions:

- When it is not possible to keep your vehicle at a set speed.
- On slippery roads, such as on snow or ice.
- In heavy or varying traffic volume, in traffic that varies in speed, or on winding roads.
- Be sure to turn the Speed Control switch to the OFF position when not in use to avoid accidental engagement.

OVERHEAD CONSOLE — IF EQUIPPED

The overhead console contains dome/reading lights, a sunroof switch (if equipped), and a Electronic Vehicle Information Center (EVIC) that consists of the following:

- Compass/temperature display
- Trip information displays
- Vehicle information warning message displays
- Customer programmable features

Pressing the MENU button will change the displayed programming features. Pressing the STEP button will select the available choices. Pressing

the C/T (Compass/Temperature) button will return the display to the normal compass/temperature display. See the appropriate heading for each display or feature for more information.

Dome/Reading Lights

Located in the console are two dome/reading lights.

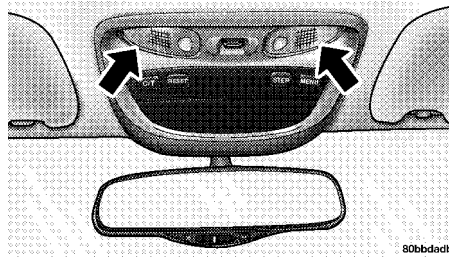

The dome/reading lights illuminate when a door or the liftgate is opened or when the interior lights are turned on by rotating the dimmer control located on the multi-function lever.

The reading lights are activated by pressing on the recessed area of the corresponding lens.

NOTE:

The dome/reading lights will remain on until the switch is pressed a second time, so be sure

they have been turned off before leaving the vehicle.

Electronic Vehicle Information Center

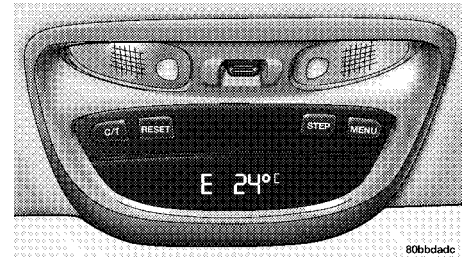

The electronic vehicle information center (EVIC), when the appropriate conditions exist, displays the following messages and symbols. Each message is accompanied by a series of beeps:

- HOOD OPEN (with graphic)
- TURN SIGNALS ON (with graphic)
- PERFORM SERVICE
- DOOR OPEN (one or more, with graphic)
- LIFTGATE OPEN (with graphic)
- LIFTGLASS OPEN (with graphic)

- COOLANT LEVEL LOW (with graphic)
- WASHER FLUID LOW (with graphic)
- MEMORY SEAT DISABLED

Customer Programmable Features

Press the MENU button until one of the following display choices appears:

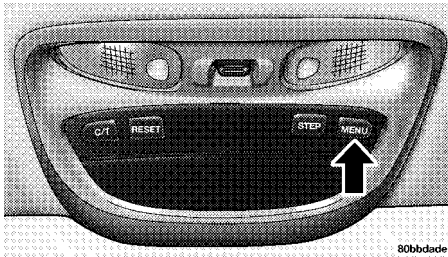

Language?

When in this display you may select one of five languages for all display nomenclature, including the trip computer functions. Press the STEP button while in this display selects English, Francais, Deutsch, Italiana or Espanol. As you continue the displayed information will be shown in the selected language.

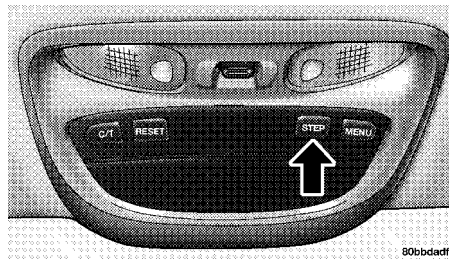

Display U.S. or Metric?

Pressing the STEP button when in this display selects US or Metric. The overhead console and instrument panel displays will be in the selected units.

Auto Door Locks?

When this feature is selected, all doors and the liftgate lock automatically when the speed of the vehicle reaches 25 km/h (15 mph). Pressing the STEP button when in this display will select "Yes" or "No."

Auto Unlock On Exit? (Available only when the AUTO DOOR LOCKS feature is turned on)

When this feature is selected all the vehicle's doors will unlock when the driver's door is opened if the vehicle is stopped, and the transmission is in

P (Park) or N (Neutral) position. Pressing the STEP button when in this display will select "Yes" or "No."

Remote Unlock Driver's Door 1st?

When this feature is selected only the driver's door will unlock on the first press of the remote keyless entry unlock button and require a second press to unlock the remaining locked doors and liftgate. When **REMOTE UNLOCK ALL DOORS** is selected all of the doors and the liftgate will unlock at the first press of the remote keyless entry unlock button. Pressing the STEP button when in this display will select DRIVER'S DOOR 1ST or ALL DOORS.

Remote Linked To Memory? (Available with Memory Seat Only)

When this feature is selected the memory seat, mirror, and radio settings will return to the memory set position when the remote keyless entry unlock button is pressed. If this feature is not selected then the memory seat, mirror, and radio settings can only return to the memory set position using the door mounted switch. Pressing the STEP button when in this display will select YES or NO.

Flash Lights with Locks?

When this feature is selected the front and rear turn signals will flash when the doors are locked or unlocked using the remote keyless entry transmitter. This feature may be selected with or without

the sound horn on lock feature selected. Pressing the STEP button when in this display will select Y (Yes) or N (No).

Headlamp Delay

When this feature is selected the driver can choose, when exiting the vehicle, to have the headlights remain on for 30, 60, or 90 seconds, or not remain on. Pressing the STEP button when in this display will select 30, 60, 90, or OFF.

Service Interval

When this feature is selected a service interval between 3200 and 12 000 kilometers (2,000 and 7,500 miles) in 800 kilometer (500 mile) increments may be selected. Pressing the STEP button when in this display will select distances between 3200 and 12 000 kilometers (2,000 and 7,500 miles) in 800 kilometer (500 mile) increments.

NOTE:

For diesel models, the service interval will be between 5000 km (3,125 miles) and 20 000 km (12,500 miles) in 5000 km (3,125 miles) increments.

Reset Service Distance? (Displays Only if Service Interval was Changed)

When this feature is selected the current accumulated service distance can be reset to the newly selected service interval. Pressing the STEP button when in this display will select "Yes" or "No."

Low Fuel Chime?

When this feature is selected a chime will sound when the low fuel warning light is displayed in the instrument panel cluster. Pressing the STEP button when in this display will select YES or NO.

Easy Exit Seat? (Available with Memory Seat Only)

When this feature is selected the driver's seat moves rearward 55 mm (2 inches) or to the farthest rearward position if this distance is less than 55 mm (2 inches) when the key is removed from the ignition switch so that the driver can more easily exit the vehicle. The seat will return to the memorized seat location, if REMOTE LINK TO MEMORY is set to YES, or when the remote keyless entry transmitter is used to unlock the door. Pressing the STEP button when in this display will select YES or NO.

Compass/Temperature/Trip Computer

This display provides the outside temperature, one of the eight compass headings to indicate the direction the vehicle is facing, and vehicle trip information. The compass and temperature display is the normal display. When the C/T button is pressed or the customer programmable features have been "stepped through" the compass/temperature display returns.

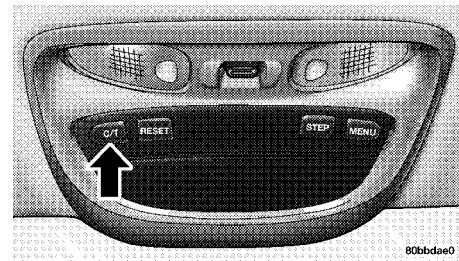
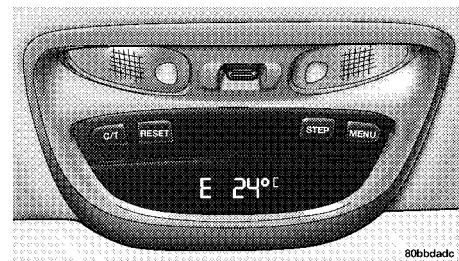

Trip Computer

This feature, located in the overhead console, displays the following information when the display is in the Compass/Temperature mode and the STEP button is pressed:

STEP Button

Press this button to cycle through all the Compass/Mini-Trip Computer displays.

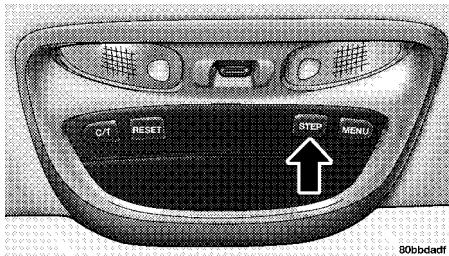

Average Fuel Economy

Shows the average fuel economy since the last reset.

Distance To Empty

Shows the estimated distance that can be traveled with the fuel remaining in the tank. This is calibrated using the kilometer per liter for the last few minutes.

Trip Odometer

Shows the distance traveled since the last reset.

Elapsed Time

Shows the accumulated ignition ON time since the last reset.

Miles to Service

Shows the distance remaining to require service.

NOTE:

This display can be reset to the set service interval by pressing the RESET button for 3 seconds.

Blank Screen

Shows a blank screen. Pressing the C/T button returns to the compass and temperature display.

Automatic Compass Calibration

This compass is self-calibrating which eliminates the need to manually set the compass. When the vehicle is new, the compass may appear erratic and the CAL symbol will be displayed.

After completing three 360° turns in an area free from large metal or metallic objects, the CAL symbol will turn off and the compass will function normally.

Manual Compass Calibration

If the compass appears erratic and the CAL symbol does not appear, you must manually put the compass into the "Calibration" mode.

NOTE:

To ensure proper compass calibration, make sure the compass variance is properly set before manually calibrating the compass. Refer to Variance Map.

To Put Into a Calibration Mode

Turn on the ignition and set the display to Compass/Temperature. Press and hold the RESET button to change the display between VAR (compass variance) and CAL (compass calibration) modes. When the CAL symbol is displayed complete three 360 degree turns in an area free from large metal objects or power lines. The CAL symbol will turn off and the compass will function normally.

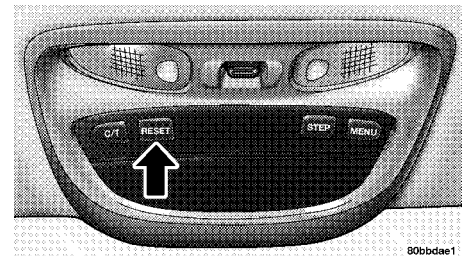

Compass Variance is the difference between magnetic north and geographic north. In some areas of the country, the difference between magnetic and geographic north is great enough to cause the compass to give false readings. If this occurs, the compass variance must be set, according to the Compass Variance Map.

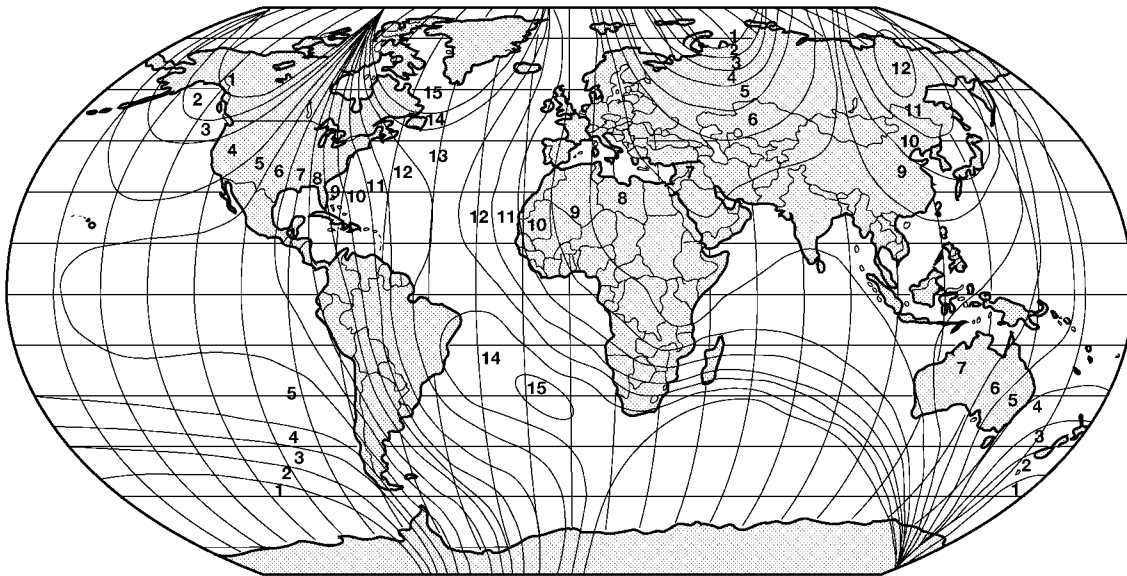

80bbc346

To set the variance: Turn the ignition ON and set the display to Compass/Temperature. Press the RESET button approximately 10 seconds. The last variance zone number will be displayed. Press the STEP button to select the new variance zone and press the reset button to resume normal operation.

POWER SUNROOF — IF EQUIPPED

The sunroof is electrically operated from a switch located in the overhead console. To operate the sunroof, the ignition switch must be in the ON or ACC position. The sunroof has "Manual" and "Express Open" modes of operation when opening.

WARNING!

Never leave children in a vehicle, with the keys in the ignition switch. Occupants, particularly unattended children, can become entrapped by the power sunroof while operating the power sunroof switch. Such entrapment may result in serious injury or death.

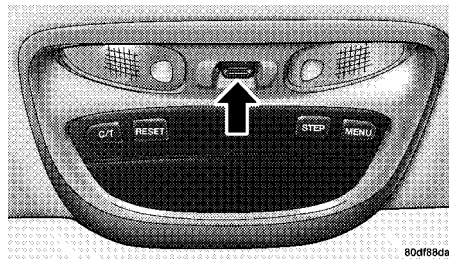

Express Open Mode

To open the sunroof in the Express Open mode, press the switch rearward for less than one second. This causes the sunroof glass to automatically retract and stop at the full open position. This glass position provides the largest possible opening while minimizing low-speed wind buffeting. If wind buffeting does occur, adjusting the sunroof glass position may reduce the intensity of the buffeting.

Manual Open Mode

The sunroof can also be opened by pressing and holding the switch rearward. Once the switch is held rearward for more than one second, releasing the switch at any time during travel will cause the sunroof to stop at the current position.

Closing Operation

To close the sunroof from an open position, press the switch forward and hold it until the sunroof glass comes to a complete stop. Releasing the switch at any time in this mode will cause the sunroof to stop at the current position.

Vent Operation

Opening the glass panel to the vent position will improve interior ventilation. To open the sunroof to the vent position from the closed position, press the switch forward and hold. Releasing the switch at any time during travel will cause the sunroof to stop at the current vent position. To reach the fully vented position, continue to hold the switch forward until vent motion stops. To close the sunroof from the vent position, press and hold the switch rearward until the glass comes to a complete stop.

Ignition Off Operation

The sunroof will also operate up to 45 seconds after the ignition has been turned off. The sunroof operation will be canceled if either of the front doors are opened during the 45 second time period.

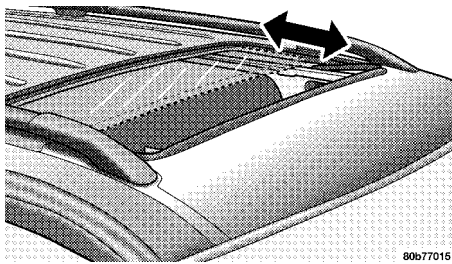

Sunshade Operation

The sunshade covering the glass in the panel will open with the sunroof and must be closed manually. It can also be opened and closed manually without activating the sunroof. This will allow you to enjoy the warmth of the sun during the winter months.

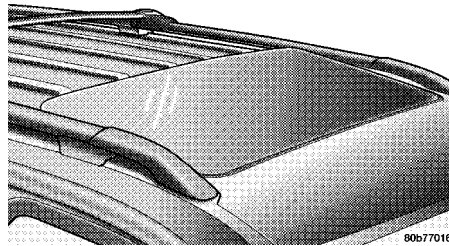

WARNING!

In an accident, there is greater risk of being thrown from a vehicle with an open sunroof. You could be seriously injured or killed. Always fasten your seat belt properly and be sure all passengers are properly secured too.

Maintenance

Care should be taken in cleaning the inside of the glass. Use only nonabrasive cleaners and a soft cloth.

WARNING!

Do not allow small children to operate the sunroof, and never allow objects to project through the sunroof opening. Injury may result.

POWER OUTLET

To the right of the ash tray is an outlet for electrically powered accessories. Press in lightly at the top of the plastic cover to open access the outlet.

There is a rear power outlet located in the right rear cargo area rearward of the storage bin/CD changer (if equipped).

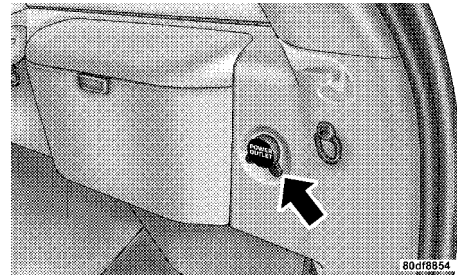

Rear Power Outlet

The power outlets are a direct feed from the battery so they receive power whether the ignition is in the ON or OFF position.

All accessories connected to this outlet should be removed or turned off when the vehicle is not in use to protect the battery against discharge.

CAUTION!
Electrical Outlet Use With Engine Off

- Many accessories that can be plugged in draw power from the vehicle's battery, even when not in use (i.e., cellular phones, etc.). Eventually, if plugged in long enough, the vehicle's battery will discharge sufficiently to degrade battery life and/or prevent engine starting.
- Accessories that draw higher power (i.e., coolers, vacuum cleaners, lights, etc.) will degrade the battery even more quickly. Only use these intermittently and with greater caution.
- After the use of high power draw accessories, or long periods of the vehicle not being started (with accessories still plugged in), the vehicle must be driven a sufficient length of time to allow the generator to recharge the vehicle's battery.

GLOVE COMPARTMENT

The glove compartment light will remain on if the glove box door is not securely closed, causing an unnecessary drain on the battery.

CUP HOLDERS

In the center console there are two cup holders for the front seat passengers.

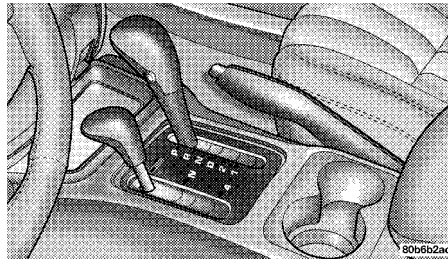

Front Cup Holders

NOTE:

The cup holder insert is removable, from the console, for cleaning. It can be reinstalled with the larger cup depression towards the passenger seat, but the top surface will not be flush with the console surface.

The rear passengers have access to two cup holders that pull out from the rear of the center console.

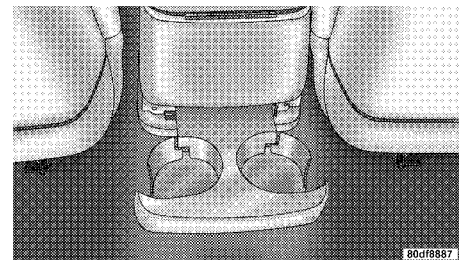

Rear Cup Holders

CARGO AREA FEATURES

Cargo Light

The cargo area light is activated by opening the liftgate, opening any door, or by rotating the dimmer control on the multi-function control lever to the extreme top position. If all doors are closed and only the liftgate is open, pushing on the cargo light lens surface will turn off all interior lamps. Push on the lens surface a second time to restore the interior lights to normal operation.

Retractable Cargo Area Cover — If Equipped

To cover the cargo area:

1. Grasp the cover at the center handle. Pull it over the cargo area.
2. Insert the pins on the ends of the cover into the slots in the pillar trim cover.
3. The liftgate may be opened with the cargo cover in place.

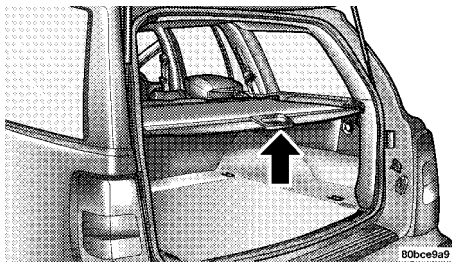

WARNING!

In an accident a cargo cover loose in the vehicle could cause injury. It could fly around in a sudden stop and strike someone in the vehicle. Do not store the cargo cover on the cargo floor or in the passenger compartment. Remove the cover from the vehicle when taken from its mounting. Do not store in the vehicle.

WARNING!

Cargo tie-down hooks are not safe anchors for a child seat tether strap. In a sudden stop or collision a hook could pull loose and allow the child seat to come loose. A child could be badly injured. Use only the anchors provided for child seat tethers.

Cargo Tie-Down Hooks

The tie-downs located on cargo area floor should be used to safely secure loads when vehicle is moving.

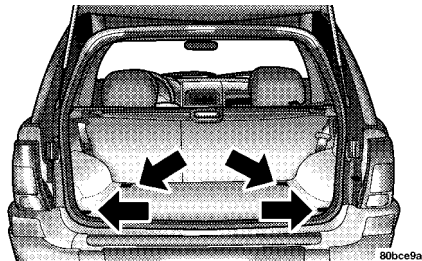

WARNING!

The weight and position of cargo and passengers can change the vehicle center of gravity and vehicle handling. To avoid loss of control resulting in personal injury, follow these guidelines for loading your vehicle:

- Do not carry loads which exceed the load limits described on the label attached to the left door or left door center pillar. Refer to "Vehicle Loading" in Section 5 for additional information on cargo weights.
- Always place cargo evenly on the cargo floor. Put heavier objects as low and as far forward as possible.
- Place as much cargo as possible in front of the rear axle. Too much weight or improperly placed weight over or behind the rear axle can cause the rear of the vehicle to sway.

- Do not pile luggage or cargo higher than the top of the seatback. This could impair visibility or become a dangerous projectile in a sudden stop or collision.

WARNING!

To help protect against personal injury, passengers should not be seated in the rear cargo area. The rear cargo space is intended for load carrying purposes only, not for passengers, who should sit in seats and use seat belts.

ROOF LUGGAGE RACK

External racks do not increase the total load carrying capacity of the vehicle. Be sure that the total occupant and luggage load inside the vehicle, plus the load on the luggage rack, do not exceed the rated vehicle capacity.

This vehicle is not equipped with roof rack cross rails as built, unless ordered as optional equipment. Cross rails must be installed prior to carrying loads on the roof rack. If not equipped, your authorized dealer can order and install Mopar® cross rails built specifically for this roof rack system or a number of after market rails that are tailored to your life-style or activities.

CAUTION!

- To prevent damage to the roof of your vehicle, **DO NOT** carry any loads on the roof rack without cross rails installed. The load should be secured and placed on top of the cross rails, not directly on the roof. If it is necessary to place the load on the roof, place a blanket or some other protection between the load and the roof surface.
- To avoid damage to the roof rack and vehicle, do not exceed the rated load capacity of your cross rail system or the roof rack system maximum load capacity of 68 kg (150 lbs). Always distribute heavy loads as evenly as possible and secure the load appropriately.
- Long loads which extend over the windshield, such as wood panels or surfboards, should be secured to both the front and rear of the vehicle.
- Travel at reduced speeds and turn corners carefully when carrying large or heavy loads on the roof rack. Wind forces, due to natural causes or nearby truck traffic, can add sudden upward loads. This is especially true on large flat loads and may result in damage to the cargo or your vehicle.

WARNING!

Cargo must be securely tied before driving your vehicle. Improperly secured loads can fly off the vehicle, particularly at high speeds, resulting in personal injury or property damage. Follow the roof rack "Cautions" when carrying cargo on your roof rack.

UNDERSTANDING YOUR INSTRUMENT PANEL

• INSTRUMENT PANEL AND INTERIOR CONTROLS	54
• INSTRUMENT CLUSTER	55
• 4.0L/4.7L ENGINE	55
• 4.7L HO ENGINE	56
• 2.7L DIESEL ENGINE	57
• INSTRUMENT CLUSTER DESCRIPTION	58
• SOUND SYSTEMS	61
• CLIMATE CONTROLS	61
• Air Conditioning	61
• Blower Control	61
• Temperature Control	61
• Mode Selection	61
• Infrared Dual-Zone Climate Control — If Equipped	62
• Window Fogging	63
• REAR WINDOW FEATURES	64
• Rear Window Wiper/Washer	64
• Rear Window Defroster	64

INSTRUMENT PANEL AND INTERIOR CONTROLS

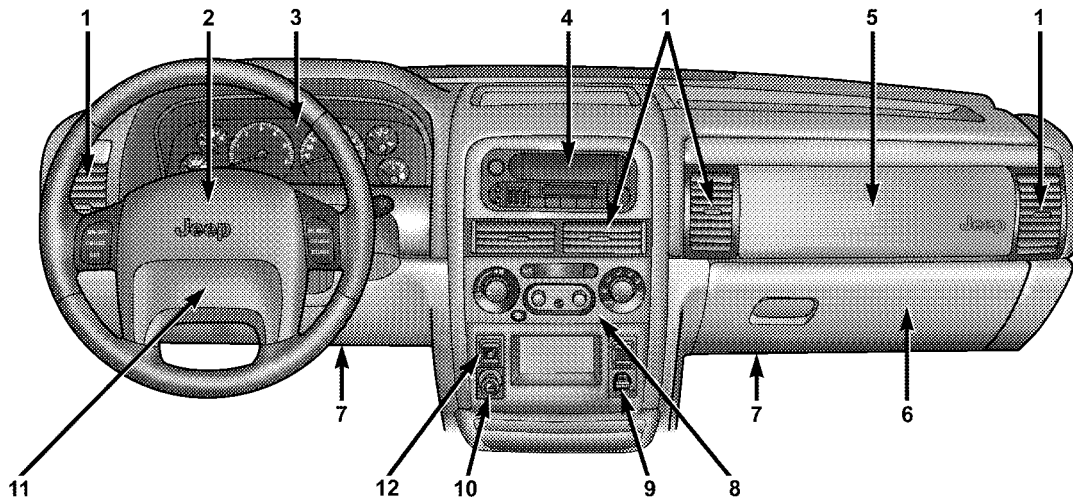

- 1. Air Outlet
- 2. Driver's Airbag
- 3. Instrument Cluster
- 4. Radio

- 5. Passenger Airbag
- 6. Glove Compartment
- 7. Knee Bolster
- 8. Climate Controls

- 9. Power Outlet
- 10. Cigar Lighter - If Equipped
- 11. Horn
- 12. Heated Seats - If Equipped

8014410e

INSTRUMENT CLUSTER
4.0L/4.7L ENGINE

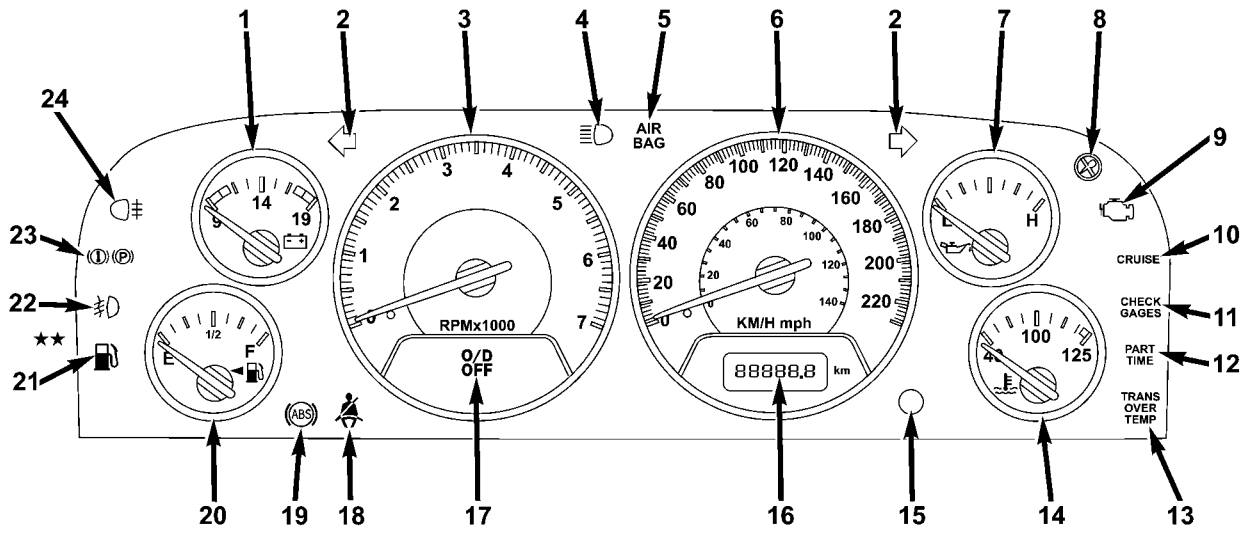

80f8039e

4.7L HO ENGINE

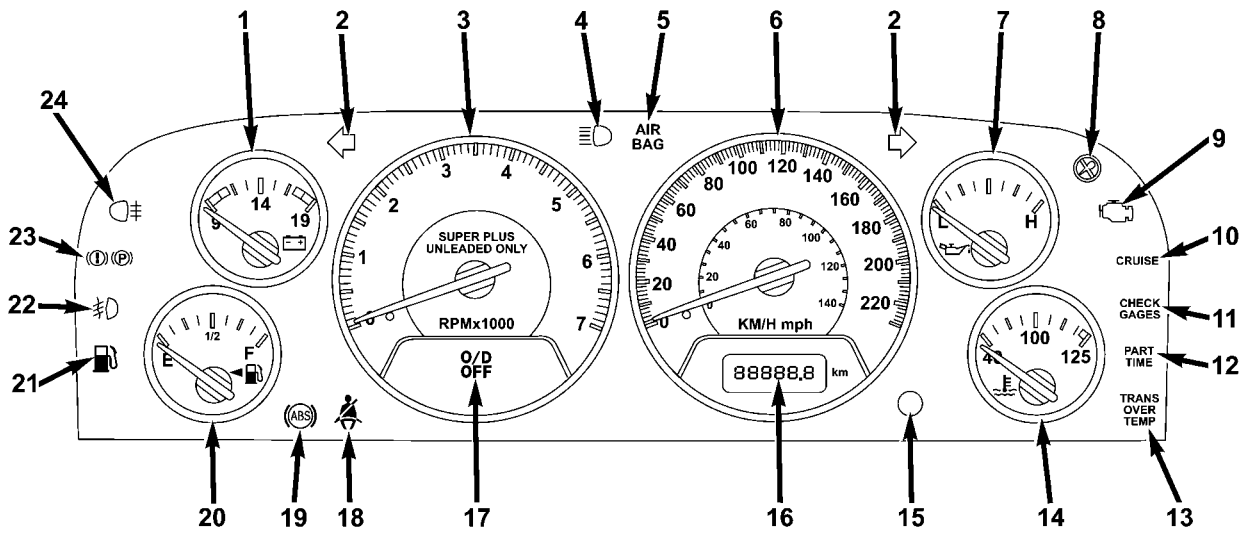

80f803a4

2.7L DIESEL ENGINE

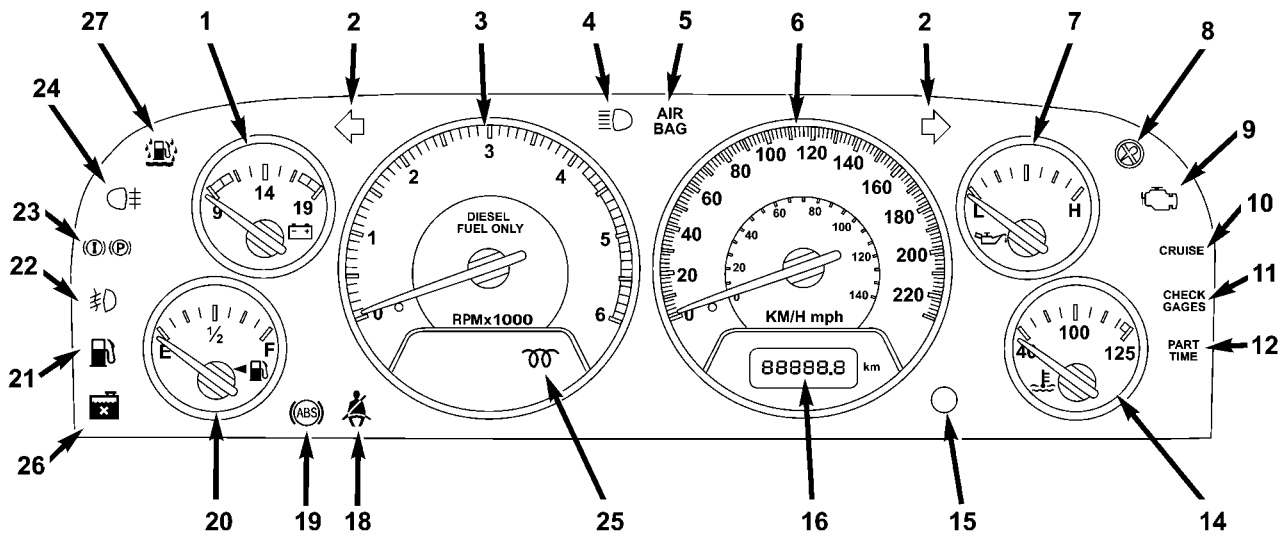

80f8049e

INSTRUMENT CLUSTER DESCRIPTION

1. Voltmeter



Indicates available battery voltage and charging system operation. The lower red zone shows that the battery charge may be too low to start the engine. With the engine running, the normal operating range is between 11 and 15 volts. Prolonged gauge readings between 9-11 (undercharge) or above 15 (overcharge) indicate possible malfunction of the alternator, voltage regulator, or battery. See your authorized dealer if such signs occur.

2. Turn Signal Indicator Light



The arrows will flash with the exterior turn signals when the multi-function control lever is operated.

3. Tachometer

Indicates the engine speed in revolutions per minute (RPM).

CAUTION!

Do not operate the engine with the tachometer pointer in the red area. Engine damage will occur.

4. High Beam Indicator Light



This light shows that the headlights are on high beam. Pull the multi-function control lever towards the steering wheel to switch the headlights from high to low beam.

5. Airbag Warning Light

AIR BAG The indicator lights and remains lit for 6 to 8 seconds when the ignition is first turned ON. If the light does not turn on, stays on or comes on while driving, have the airbag system checked by an authorized dealer.

6. Speedometer

Indicates vehicle speed.

7. Oil Pressure Gage



Indicates the engine oil pressure. This gauge does not measure oil level. Pressure varies with engine speed, temperature, and oil viscosity. Consistent lower readings indicate a possible malfunction. Seek authorized service.

8. Sentry Key Indicator Light



Refer to "Sentry Key Immobilizer System" in Section 2 of this manual for more information.

9. Malfunction Indicator Light



This light is part of an onboard diagnostic system called OBD that monitors engine and automatic transmission control systems. The "Malfunction Indicator Light" will illuminate briefly when the ignition key is in the ON position before engine start. If the bulb does not come on when turning the key from OFF to ON, have the condition checked promptly.

Certain conditions such as a loose gas cap, poor fuel quality, etc. may illuminate the light after engine start. The vehicle should be serviced if the light stays on through several typical driving cycles. In most situations, the vehicle will drive normally and will not require towing.

The "Malfunction Indicator Light" will flash to alert the driver of serious conditions that could lead to immediate loss of power or severe catalytic converter damage. The vehicle should be serviced as soon as possible if this occurs.

10. Cruise Indicator Light

CRUISE

This indicator lights when the electronic speed control system is turned on.

11. Check Gages Warning Light

CHECK GAGES This light illuminates when the voltmeter, oil pressure, or coolant temperature gages indicate a reading either too high or too low.

NOTE:

When the ignition switch is turned to OFF, the fuel gage, voltmeter, oil pressure, and temperature gages will not show any readings. When the engine is not running, turn the ignition switch to ON to obtain accurate readings.

12. Part Time Indicator Light — If Equipped

PART TIME This light indicates that the transfer case shift lever has been moved to the 4x4 PART TIME position. The light may flash momentarily when you begin to shift from 2WD (High Range) to 4x4 PART TIME. The light will remain fully illuminated when the shift is completed.

13. Transmission Over Temperature Warning Light — If Equipped

TRANS OVER TEMP This light indicates that there is excessive transmission fluid temperature that might occur with severe usage such as trailer towing or snow plowing. If this light comes on, stop the vehicle and run the engine at idle or faster, with the transmission in N (Neutral) until the light goes off.

This light will come on for 3 seconds as a bulb check when the ignition is first turned ON.

14. Temperature Gage



Indicates engine coolant temperature. The red zone to the far right signals possible overheating. Seek authorized service immediately if the gage operates in the red zone. Refer to "Maintenance Procedures" in Section 7 of this manual.

CAUTION!

Do not leave your vehicle unattended with the engine running as you would not be able to react to the temperature indicator if the engine overheats.

15. Reset Button

Pressing this button toggles between the odometer and trip odometer display. Also, when the trip odometer is displayed, press the "Reset" button for 2 to 3 seconds to reset the trip odometer.

16. Odometer/Trip Odometer

The odometer shows the total distance the vehicle has been driven. There are six digits including leading zeros. The odometer is tamper-resistant.

The trip odometer records the distance the vehicle has been driven since the "Reset" button was pushed. To switch from the odometer being

displayed to the trip odometer being displayed, press the "Reset" button.

17. O/D (Overdrive) Off Indicator Light — If Equipped

O/D OFF The O/D OFF button is located on the gear shift lever. This light will illuminate when the O/D OFF button has been selected.

This light will come on for 3 seconds as a bulb check when the ignition is first turned ON.

18. Seat Belt Indicator Light



A warning chime and an indicator light will alert you to buckle the seat belts. When the belt is buckled, the chime will stop, but the light will stay on until it times out (about 6 seconds).

After bulb proveout, the indicator light will illuminate anytime the driver's seatbelt is unbuckled.

19. Anti-Lock Warning Light



The amber "Anti-Lock Warning Light" will come on when the ignition is first turned ON and stay on briefly as a bulb check. If the bulb does not come on during starting, have the bulb repaired promptly. This light also illuminates to indicate that the Anti-Lock Brake System self-check is in process at vehicle start-up. If the light remains on after start-up, or comes on and stays on at road speeds, it may indicate that the ABS has detected a malfunction

or has become inoperative. The system reverts to standard non-anti-lock brakes. Turn the engine OFF and ON again to reset Anti-Lock Brake System. If the light remains on, see your authorized dealer. If both the red "Brake Warning Light" and the amber "Anti-Lock Warning Light" are on, see your authorized dealer immediately.

20. Fuel Gage

Indicates the level of fuel in the fuel tank. A small arrow indicates the side of the vehicle where the filler cap (gas cap) is located.

21. Low Fuel Warning Light

 Glows when approximately 11.2L (2.5 U.S. Gallons) remain in the fuel tank. The "Low Fuel Warning Light" may turn ON and OFF again, especially during and after hard braking, accelerations, or turns. This occurs due to the shifting of the fuel in the tank.

Your vehicle has a programmable electronic feature that will sound a chime when the "Low Fuel Warning Light" comes on. See the information on "Customer Programmable Features" in the overhead console to turn this feature on.

This light will come on for 3 seconds as a bulb check when the ignition is first turned ON.

22. Front Fog Light Indicator Light

 This light illuminates when the front fog lights are ON.

23. Brake Warning Light

 The red "Brake Warning Light" will come on when the ignition is first turned ON and stay on briefly as a bulb check. If the bulb does not come on during starting, have the bulb repaired promptly. This light also indicates that the parking brake is applied. If the light stays on when the parking brake is off, it indicates a possible brake system fluid leak. See your authorized dealer immediately.

WARNING!
Driving a vehicle with the "Brake Warning Light" on is dangerous. Part of the brake system may have failed. It will take longer to stop the vehicle. You could have an accident. Have the vehicle checked immediately.

NOTE:
This light shows only that the parking brake is on or that the brake fluid is low. It does not show the degree of brake application.

24. Rear Fog Light Indicator Light

 This light illuminates when the rear fog lights are ON.

25. Glow Plug Indicator Light — If Equipped

 This light will illuminate when the ignition switch is first turned to the ON position. Wait until the light turns OFF before starting the vehicle. Refer to "Starting Procedures" in Section 5 of this manual.

26. Low Coolant Warning Light — If Equipped

 This light comes on if the coolant level is low. This light will come on for 3 seconds as a bulb check when the ignition is first turned ON.

27. Water In Fuel Warning Light — If Equipped

 This light indicates water has collected in the fuel filter and should be drained immediately.

SOUND SYSTEMS

Refer to your Sound Systems Booklet.

CLIMATE CONTROLS

Air Conditioning

The controls for the heating/air conditioning and ventilation system in this vehicle consist of a series of rotary knobs. These comfort controls can be set to obtain desired interior conditions.

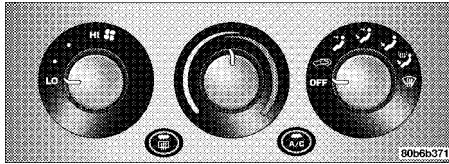

Air conditioning can be obtained by depressing the "A/C" button on the control panel and setting the appropriate rotary knobs to obtain the desired comfort level.

Blower Control

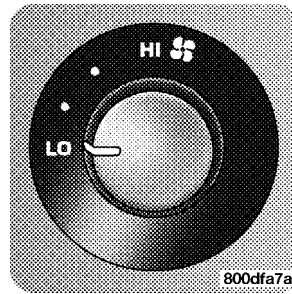

The rotary knob on the left controls the blower and can be set in one of four positions from LO to HI. **The blower fan motor will remain on until the system is turned to the OFF position or the ignition is turned OFF.**

Temperature Control

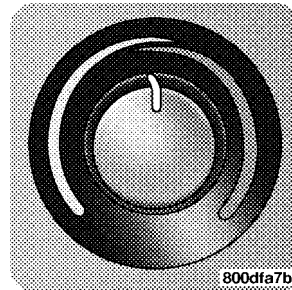

The degree of comfort can be selected by rotating the temperature control knob in the center. The coldest temperature setting is on the extreme left and the warmest setting on the extreme right of the rotation. The knob can be positioned at any point on the dial.

Mode Selection

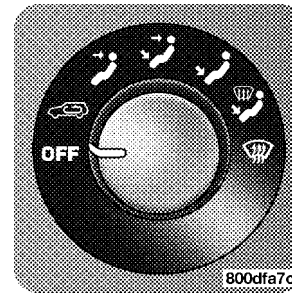

The mode selector (the right rotary knob) can be set in any of the following positions:

OFF

This position turns off the blower motor and outside air will not pass through any outlets.

Recirculation



The recirculation feature can be selected with the mode control knob. Outside air is normally drawn into the vehicle in all of the other modes, such as panel air, bi-level, floor, floor/defrost, and the defrost air distribution outlets. Air flows through the outlets located in the instrument panel. Use this mode to rapidly cool the inside of the vehicle. The Recirculation mode can also be used to temporarily block out outside odors, smoke, and dust.

Panel

 Air flows through the outlets located in the instrument panel.

Bi-Level

 Air flows both through the outlets located in the instrument panel and those located on the floor.

Floor

 Air flows through the floor outlets located under the instrument panel and into the rear seating area through vents under the front seats.

Defrost/Floor

 Air flows through the front and rear floor outlets and the outlets at the base of the windshield.

Defrost

 Air is directed to the windshield through the outlets at the base of the windshield.

NOTE:

To improve fuel economy, leave in defrost only when necessary.

Infrared Dual-Zone Climate Control — If Equipped

The Infrared Dual-Zone Climate Control System automatically maintains the interior comfort level desired by the driver and passenger. This is accomplished by using a dual infrared sensor located in the face of the control unit. The dual infrared sensor independently measures the surface temperature of the driver and passenger. Based on the sensor input, the system automatically adjusts the air flow temperature, the air flow volume, and amount of outside air recirculation. This maintains a comfortable temperature even under changing conditions.

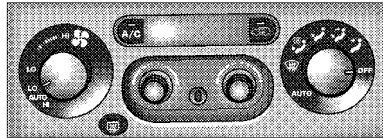

80b6b2d9

Operation of the system is quite simple. Begin by turning the right mode knob to AUTO. Dial in the temperature you would like the system to maintain by rotating the driver's or passenger's control knob. Once the comfort level is displayed the system will maintain that level automatically using the heating system. Should the desired comfort level require air conditioning, the system will automatically make the adjustment.

You may notice the blower speed getting lower as the difference between the driver and passenger temperature settings gets larger. This is an extreme condition and the airflow may not perform as anticipated.

The temperature can be displayed in U.S. or Metric by selecting the US/M customer programmable feature. Refer to the "Overhead Console-Customer Programmable Features" in Section 3 of this manual.

The left knob controls the blower fan. Within the AUTO setting on this control, you can select a HI volume of air from the blower or a LO volume. Once the system is set up for your comfort level, it is not necessary to change the setting. You will experience the greatest efficiency by simply allowing the system to function automatically.

Manual Operation

However, this system does offer a full complement of manual override features. There is a manual blower range used when the AUTO setting is not desired. The left control can be set to any fixed blower speed by rotating the knob from LO to HI on the upper portion of the dial.

The operator can override the AUTO mode setting and select the direction of the air by rotating the right mode knob to one of the following positions.

- **Defrost**



Air is directed to the windshield through the outlets at the base of the windshield.

- **Defrost/Floor**



Air flows through the front and rear floor outlets and the outlets at the base of the windshield.

- **Floor**



Air flows through the floor outlets located under the instrument panel and into the rear seating area through vents under the front seats.

- **Bi-Level**



Air flows both through the outlets located in the instrument panel and those located on the floor.

- **Panel**



Air flows through the outlets located in the instrument panel.

- **OFF**

This position turns off the entire system.

Depress the A/C button to turn on and off the air conditioning during manual operation only. Conditioned outside air is then directed through the outlets selected on the mode control dial.

When the outside air contains smoke, odors, high humidity, or if rapid cooling is desired you may wish to recirculate interior air by pressing the "Recirculate" icon button. The recirculation mode should only be used temporarily. The light on the A/C and "Recirculate" icon buttons will illuminate when these buttons are selected. You may use these features separately or with one another. Push in on the buttons a second time to change the functions.

NOTE:

If the interior of the windows begins to fog, press the "Recirculate" icon button to return to outside air. Some temp./humidity conditions will cause captured interior air to condense on windows and hamper visibility. For this reason, the system will not allow "Recirculate" to be selected while in the defrost or defrost/floor modes.

To provide you with maximum comfort in the automatic mode, during cold start-ups the blower fan will remain off until the engine warms up. However, the fan will engage immediately if the defrost mode is selected or if you select a fixed blower speed.

Window Fogging

Vehicle windows tend to fog on the inside in mild rainy or humid weather. To clear the windows, use the A/C, panel, and blower controls. Direct the panel outlets toward the side windows. Recirculate without A/C should not be used for long periods as fogging may occur. Interior fogging on the windshield can be quickly removed by using the defrost mode.

REAR WINDOW FEATURES

Rear Window Wiper/Washer

A switch on the right side of the steering column controls operation of the rear wiper/washer function. Rotating the center of the switch up to the DEL (Delay) position or the ON position will activate the wiper. Push the lever forward to initiate the wash function in any of the three positions. The wash pump will continue to operate as long as the button is pressed. Upon release, the wipers will cycle three times before returning to the set position.

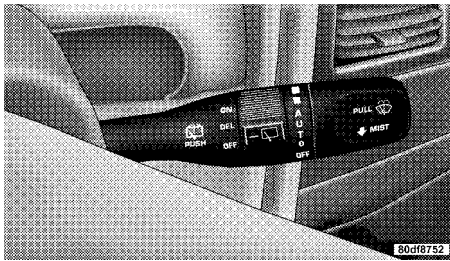

If the rear wiper is operating when the ignition is turned OFF, the wiper will automatically return to the "Park" position.

If the liftgate flipper glass is open, connection to the rear window wiper is interrupted preventing activation of the rear wiper blade. When the liftgate flipper glass is closed, the rear wiper switch or the ignition switch needs to be turned OFF and ON to restart the rear wiper.

Rear Window Defroster



In the lower left of the climate control panel is a push button for rear window defrosting. An amber indicator in the push button will light when the defroster is turned on. Push again to turn off the defroster prior to an automatic time-out.

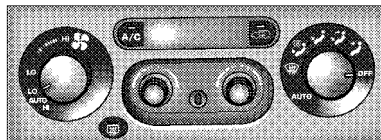

80b6b2d9

The defroster will automatically turn off after about ten minutes. For about five more minutes of operation, push the button again. To prevent excessive battery drain, use the defroster only when the engine is operating. The push button also activates the heated exterior mirrors, if so equipped.

CAUTION!

Use care when washing the inside of the rear window to prevent damage to heating elements. Use a soft cloth and a mild washing solution, wiping parallel to the heating elements. Also, keep all objects a safe distance from the window to prevent damaging the heating elements.

STARTING AND OPERATING

• STARTING PROCEDURE	68
• Normal Starting — Gasoline Engines	68
• If Engine Fails to Start	68
• Normal Starting — Diesel Engines	68
• AUTOMATIC TRANSMISSION	70
• Brake Transmission Shift Interlock System (BTSI)	70
• Electronically Controlled Five Speed Automatic Transmission (4.7L Engine Only)	70
• Protect Mode - Electronically Controlled Transmission (4.7L Engine Only)	70
• Gear Ranges	70
• Over Temperature Mode	72
• Torque Converter Clutch	72
• Rocking the Vehicle	72
• Electronically Controlled Five Speed Automatic Transmission (2.7L Turbo Diesel Engine Only)	73
• Protect Mode - Electronically Controlled Transmission	73
• Gear Ranges	73
• FOUR-WHEEL DRIVE OPERATION	74
• Quadra-Trac II Operating Instructions/Precautions	74

- Shift Positions 75
- Shifting Procedure 75
- Quadra-Drive System — If Equipped 75
- VARI-LOK FRONT AND REAR AXLES — IF EQUIPPED 76
- PARKING BRAKE 76
- ANTI-LOCK BRAKE SYSTEM 77
- ON-ROAD DRIVING TIPS 78
- OFF-ROAD DRIVING TIPS 78
 - When To Use 4 LO (Low) Range 78
 - In Snow, Mud and Sand 78
 - Hill Climbing 78
 - Traction Downhill 78
 - After Driving Off-Road 79
- FUEL REQUIREMENTS 79
 - Methanol 79
 - Clean Air Gasoline 80
 - Materials Added to Fuel 80
- FUEL REQUIREMENTS — DIESEL 80
- FUEL TANK FILLER CAP (GAS CAP) 80
- TIRES AND WHEELS 81
 - Tire Usage 81
 - Tire Maintenance 81
 - Tire Inflation Pressures 82
 - Tire Rotation 82
 - Alignment and Balance 82

- Replacement Tires 83
- Tire Chains or Traction Devices 83
- Tire Spinning 84
- Treadwear Indicators 84
- TRAILER TOWING 84
 - Trailer and Tongue Weight 85
 - Minimum Vehicle Requirements for Trailer Towing 85

STARTING PROCEDURE

Start the engine with the selector lever in the N (Neutral) or P (Park) position. Apply the brake before shifting to any driving range.

Normal Starting — Gasoline Engines

Normal starting of either a cold or a warm engine is obtained without pumping or depressing the accelerator pedal. Turn the key to the START position and release when the engine starts. If the engine fails to start within 10 seconds, turn the key to the OFF position, wait 5 seconds, then repeat the normal starting procedure.

If Engine Fails to Start

If the engine fails to start after you have followed the normal starting procedure, it may be flooded. Push the accelerator pedal all the way to the floor and hold it there while cranking the engine. This should clear any excess fuel in case the engine is flooded.

NOTE:

To prevent damage to the starter, do not crank the engine for more than 15 seconds at a time. Wait 10 to 15 seconds before trying again.

If the engine has been flooded, it may start to run, but not have enough power to continue running when the key is released. If this occurs, continue cranking with the accelerator pedal pushed all the

way to the floor. Release the accelerator pedal and the key once the engine is running smoothly.

If the engine shows no sign of starting after two 15 second periods of cranking with the accelerator pedal held to the floor, the normal starting procedure should be repeated.

WARNING!

Never pour fuel or other flammable liquids into the throttle body air inlet opening in an attempt to start the vehicle. This could result in a flash fire causing serious personal injury.

Normal Starting — Diesel Engines

1. Turn the ignition key to the ON position.
2. Watch the "Glow Plug Indicator Light." It will glow for two to ten seconds or more, depending on engine temperature. When the glow plug light goes out, the engine is ready to start.
3. **Do not** press the accelerator. Turn the ignition key to START and hold it in this position until the engine starts.
4. After the engine starts, allow it to idle for approximately 30 seconds before driving. This allows oil to circulate and lubricate the turbo-charger.

NOTE:

In cold weather, -15°C (5°F) repeat step 2. When the pre-heat light goes off, turn the ignition key to the OFF position then to ON once more and wait for the pre-heat light a second time. Now the engine is ready to start.

Starting and Operating Cautions — Diesel Engines

WARNING!

NEVER pour fuel or other flammable liquid into the air inlet opening in an attempt to start the vehicle. This could result in a flash fire causing serious personal injury.

- Under normal conditions, **do not** operate the starter for longer than 15 seconds at one time. At temperatures below -15°C (5°F), you may operate the starter for up to 30 seconds at one time. Longer periods of operation may result in starter or battery damage. If the engine does not start at once, repeat steps 2 and 3.
- Running a cold engine at high speeds during driving or idling may damage engine components.
- **Before turning off your turbo diesel engine, always allow the engine to return to normal**

idle speed and run for several seconds. This assures proper lubrication of the turbocharger. This is particularly necessary after any period of hard driving.

NOTE:
Letting the engine idle after extended operation allows the turbine housing to cool to normal operating temperature.

The following chart should be used as a guide in determining the amount of engine idle time required to sufficiently cool down the turbocharger before shut down, depending upon the type of driving and the amount of cargo.

Turbocharger "Cool Down"

TURBOCHARGER "COOL DOWN" CHART			
Driving Conditions	Load	Turbocharger Temperature	Idle Time (in minutes) Before Shut Down
Stop & Go	Empty	Cool	Less than 1
Stop & Go	Medium	Warm	1
Highway Speeds	Medium	Warm	2
City Traffic	Max. GCWR	Warm	3
Highway Speeds	Max. GCWR	Warm	4
Uphill Grade	Max. GCWR	Hot	5

AUTOMATIC TRANSMISSION

The pointer on the selector indicates the transmission gear range (selector is illuminated for night driving). Start the engine with the selector lever in N (Neutral) or P (Park) position.

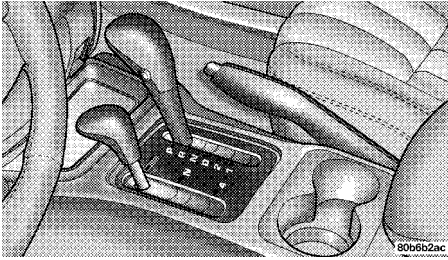

NOTE:

When the ignition is in the ON position, the brake pedal must be pressed to move the gearshift lever out of P (Park).

Brake Transmission Shift Interlock System (BTSI)

This system prevents you from moving the gear shift out of P (Park) and into any gear unless the brake pedal is pressed. This system is active only while the ignition switch is in the ON positions. Always depress the **brake pedal first**, before moving the gear selector out of P (Park).

Electronically Controlled Five Speed Automatic Transmission (4.7L Engine Only)

This electronically controlled transmission provides a precise shift schedule. The transmission electronics are self calibrating; therefore, the first few shifts on a new vehicle may be somewhat abrupt. This is a normal condition, and precision shifts will develop within a couple hundred miles.

Protect Mode - Electronically Controlled Transmission (4.7L Engine Only)

This transmission is monitored electronically for abnormal conditions. If an abnormal condition is detected, the transmission's electronic controller will automatically select direct gear (in the Drive position) or 2nd gear (in the 2 or 1 position). This feature will allow the vehicle to be driven to the dealer for service minimizing any damage to the transmission. Some conditions that will cause the transmission to use this alternate gear selection are momentary and the transmission can be reset to the normal shift program by performing the following:

- Stop the vehicle and shift into P (Park).
- Turn the ignition key to the OFF position and then restart the engine.

- Shift into the desire shift range and resume driving.

NOTE:

Even if the transmission can be reset, it is recommend that you see your dealer at your earliest possible convenience. Your dealer has the proper diagnostic equipment to determine if the problem could recur. If the transmission is cannot be reset, dealer service is required.

Gear Ranges

DO NOT race the engine when shifting from P (Park) or N (Neutral) position into another gear range.

P (Park)

Supplements the parking brake by locking the transmission. The engine can be started in this range. Never use P (Park) while the vehicle is in motion. Apply the parking brake when leaving the vehicle in this range. Always apply the parking brake first, then place the selector in P (Park) position.

WARNING!

- Your vehicle could move and injure you and others if it is not completely in P (Park). Check by trying to move the gearshift lever back and forth without depressing the shift button after you have set it in P (Park). Make sure it is in P (Park) before leaving the vehicle.
- Never use P (Park) position on an automatic transmission as a substitute for the parking brake. Always apply parking brake fully when parked to guard against vehicle movement and possible injury or damage.

CAUTION!

Before moving the shift lever out of P (Park), you must turn the ignition from LOCK to ON so the shift lever is released. Otherwise, damage to shifter could result.

R (Reverse)

Use this range only after the vehicle has come to a complete stop.

N (Neutral)

Shift to N (Neutral) when the vehicle is standing for prolonged periods with the engine running. The engine may be started in this range. Set the parking brake if you must leave the vehicle.

Overdrive

D For most city and highway driving. The transmission contains electronically controlled 4th and 5th gears (Overdrives) and will automatically shift from D (Drive) to 4th and 5th gears if the following conditions are present:

- The transmission selector is in D (Drive).
- The O/D OFF switch has not been activated.
- Vehicle speed is above approximately 48 km/h (30 mph).
- Transmission has reached normal operating temperature.

When frequent transmission shifting occurs while using overdrive, such as when operating the vehicle under heavy load conditions (for example, in hilly terrain, strong head winds, or trailer towing), turning off overdrive will improve performance and extend transmission life by reducing excessive shifting and heat buildup.

4th and 5th gears (Overdrive) can be locked out by pressing the O/D OFF switch located on side of the gearshift lever. The O/D OFF indicator light will illuminate to show that the switch has been activated. When the light is on, 4th and 5th gear (Overdrive) is locked out. Pressing the switch a second time restores the Overdrive function. The lockout feature is useful when towing a trailer or carrying a heavy load.

The O/D OFF feature must be selected, if desired, each time the engine is started.

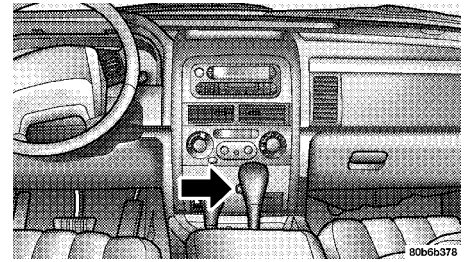
**NOTE:**

If the vehicle is started in cold outside temperatures, shifts into Overdrive may be delayed (4.7L engines only). Normal Overdrive and shifting operation will resume when the temperature of the transmission reaches the appropriate temperature. Refer to the "Note" under "Torque Converter Clutch" later in this section.

If the transmission temperature gets too hot, the transmission may downshift out of Overdrive or engage overdrive at higher vehicle speeds (4.7L engines only) until the transmission cools down. After cooldown, Overdrive will resume normal operation.

2 (Second)

For driving slowly in heavy city traffic or on mountain roads where more precise speed control is desirable. Use it also when climbing long grades, and for engine braking when descending moderately steep grades. To prevent excessive engine speed, do not exceed 45 mph (72 km/h) in this range.

1 (First)

For driving up very steep hills and for engine braking at low speeds (40 km/h (25 mph) or less) when going downhill. To prevent excessive engine speed do not exceed 40 km/h (25 mph) in this range.

CAUTION!

Never race the engine with the brakes on and the vehicle in gear, and never hold the vehicle on an incline without applying the brakes. These practices can cause overheating and damage to the transmission.

Over Temperature Mode

The transmission electronics constantly monitor the transmission oil temperature. If the transmission gets too hot, the transmission will change the way it shifts to help control the condition. This may result in a slightly different feeling or response during normal operation in D (Drive) position. If

the transmission becomes hot enough the O/D OFF indicator light and TRANS OVER TEMP warning light in the instrument cluster may come on. After the transmission cools down, it will return to normal operation.

Torque Converter Clutch

A feature designed to improve fuel economy has been added to the automatic transmission of this vehicle. A clutch within the torque converter engages automatically at calibrated speeds. This may result in a slightly different feeling or response during normal operation in high gear. When the vehicle speed drops or during acceleration, the clutch automatically and smoothly disengages.

NOTE:

- **The torque converter clutch will not engage until the transmission fluid and engine coolant are warm (usually after 1.6–4.8 km (1–3 miles) of driving). Because engine speed is higher when the torque converter clutch is not engaged, it may seem as if the transmission is not shifting into “Overdrive” when cold. This is considered a normal condition. Pressing the “O/D OFF” switch will show that the transmission is able to shift into and out of “Overdrive.”**

- **If the vehicle has not been driven for several days, the first few seconds of operation after shifting the transmission into gear may seem sluggish. This is due to the transmission fluid partially draining from the torque converter into the transmission. This is considered a normal condition and will not cause damage to the transmission. The torque converter will refill within 5 seconds of shifting from P (Park) into any other gear position.**

Rocking the Vehicle

If the vehicle becomes stuck in snow, sand, or mud, it can often be moved by a rocking motion. Move the gear selector rhythmically between “First” and R (Reverse), while applying slight pressure to the accelerator.

The least amount of accelerator pedal pressure to maintain the rocking motion without spinning the wheels or racing the engine is most effective. Racing the engine or spinning the wheels, due to the frustration of not freeing the vehicle, may lead to transmission overheating and failure. Allow the engine to idle with the transmission selector in N (Neutral) for at least one minute after every five rocking-motion cycles. This will minimize overheating and reduce the risk of transmission failure during prolonged efforts to free a stuck vehicle.

CAUTION!

When “rocking” a stuck vehicle by moving between “First” and R (Reverse), do not spin the wheels faster than 24 km/h (15 mph), or drivetrain damage may result.

Electronically Controlled Five Speed Automatic Transmission (2.7L Turbo Diesel Engine Only)

This electronically controlled transmission provides precise control of shift schedule and quality. The electronic transmission controls adapt to the respective operating conditions. On a new vehicle, the shifts may not be optimized. This is a normal condition, and precision shifts will develop within a few hundred miles.

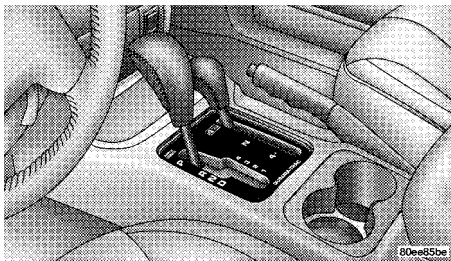
**Protect Mode - Electronically Controlled Transmission**

This transmission is monitored electronically for abnormal conditions. If an abnormal condition is detected, the transmission will remain in the current shifted gear. Under these conditions, the customer should perform the following reset procedure:

- Stop the vehicle and move the shifter into the P (Park) position.
- Turn the ignition key to the OFF position, wait 10 seconds, and then restart the engine.
- Shift into the desired shift range and resume driving.

Under some conditions, the above procedure will reset transmission function to the normal shift program. If normal operation cannot be resumed, the transmission will operate in 2nd gear with the selector lever in the D (Drive) position and reverse gear with the selector lever in the R (Reverse) position.

NOTE:

Even if the transmission can be reset, it is recommended that you see your dealer at your earliest possible convenience. Your dealer has the proper diagnostic equipment to determine if service is required. If the transmission cannot be reset, dealer service is required.

Gear Ranges

DO NOT race the engine when shifting from P (Park) or N (Neutral) position into another gear range.

P (Park)

Supplements the parking brake by locking the transmission. The engine can be started in this range. Never move the selector to P (Park) while the vehicle is in motion. Apply the parking brake when leaving the vehicle in this range. Always apply the parking brake first, then place the selector in P (Park) position.

R (Reverse)

Provides reverse gear operation. Move the selector to R (Reverse) only after the vehicle has come to a complete stop.

N (Neutral)

Shift into N (Neutral) when the vehicle is idling (engine running) in gear for prolonged periods to reduce heat buildup. The engine may be started in this range.

WARNING!

Vehicle is free to move in this range. Make sure the parking brake is set if you must leave the vehicle.

D (Drive)

For most city and highway driving. All five forward gears are available in this range. 5th gear provides overdrive operation for improved fuel economy and reduced engine speeds.

4 (Fourth)

The 4 (Fourth) range will provide normal upshifting to 4th gear. This range reduces shifting when operating the vehicle under heavy load conditions (for example, in hilly terrain, strong head winds, or trailer towing). This range will improve performance and extend transmission life by reducing excessive shifting and heat buildup.

3 (Third)

The 3 (Third) range will provide normal upshifting to 3rd gear. Use this range for enhanced speed control when operating in heavy city traffic or on mountain roads. Also, use it when climbing moderate grades and for engine braking when descending moderately steep grades.

2 (Second)

The 2 (2nd) range will provide normal upshifting to 2nd gear. Use of this range is similar to the 3 (Third) range.

1 (First)

The 1 (First) range should be used for driving up very steep hills and for engine braking at low speeds (40 km/h (25 mph) or less) when going

downhill. To prevent excessive engine speed do not exceed 40 km/h (25 mph) in this range.

FOUR-WHEEL DRIVE OPERATION

Quadra-Trac II Operating Instructions/Precautions

The Quadra-Trac II transfer case is fully automatic in the normal driving 4 ALL TIME mode. The Quadra-Trac II transfer case provides three mode positions — four wheel drive high range, neutral, and four wheel drive low range.

This transfer case is fully automatic in the 4 ALL TIME mode. The 4 ALL TIME mode transmits torque to the rear axle during normal driving, similar to a rear wheel drive vehicle. When speed difference is increased between the front and rear driveshafts the majority of engine torque can be transmitted to the front driveshaft.

When additional traction is required, the 4LO position can be used to lock the front and rear driveshafts together and force the front and rear wheels to rotate at the same speed. The 4LO position is intended for loose, slippery road surfaces only. Driving in the 4LO position on dry hard surfaced roads may cause increased tire wear and damage to driveline components.

When operating your vehicle in 4LO, the engine speed is approximately three times that of the 4 ALL TIME position at a given road speed. Take care not to overspeed the engine and do not exceed 40 km/h (25 mph).

Proper operation of four wheel drive vehicles depends on tires of equal size, type, and circumference on each wheel. Any difference will adversely affect shifting and cause damage to the transfer case.

Because four wheel drive provides improved traction, there is a tendency to exceed safe turning and stopping speeds. Do not go faster than road conditions permit.

WARNING!

You or others could be injured if you leave the vehicle unattended with the transfer case in the N (Neutral) position without first fully engaging the parking brake. The transfer case N (Neutral) position disengages both the front and rear driveshafts from the powertrain and will allow the vehicle to move regardless of the transmission position. The parking brake should always be applied when the driver is not in the vehicle.

Shift Positions

For additional information on the appropriate use of each transfer case mode position, see the information below:

4 ALL TIME

Normal All Wheel Drive High Range — All roads surfaces such as ice, snow, gravel, sand, and dry hard pavement.

N (Neutral)

Neutral — Disengages both the front and rear driveshafts from the powertrain. To be used for flat towing behind another vehicle.

4LO

Four Wheel Drive Low Range — Low speed 4 wheel drive. Locks the front and rear driveshafts together. Forces the front and rear wheels to rotate at the same speed. Additional traction and maximum pulling power for loose, slippery road surfaces only. Do not exceed 40 km/h (25 mph).

Shifting Procedure

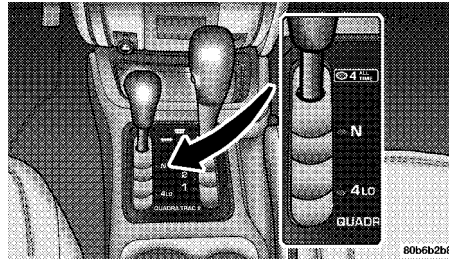

4 ALL TIME to 4 LO or 4 LO to 4 ALL TIME (Gasoline Models Only)

With the vehicle rolling at 3 to 5 km/h (2 to 3 mph), shift the transmission into N (Neutral). While the vehicle is coasting at 3 to 5 km/h (2 to 3 mph), shift the transfer case lever firmly into the desired position. Do not pause in transfer case N (Neutral).

NOTE:

Pausing in transfer case N (Neutral) in vehicles equipped with an automatic transmission may require shutting the engine OFF to avoid gear clash while completing the shift. If difficulty occurs, shift the transmission into N (Neutral), hold foot on brake, and turn the engine OFF. Make shift to desired mode.

NOTE:

Shifting into or out of 4LO is possible with the vehicle completely stopped, however difficulty may occur due to the mating clutch teeth not being properly aligned. Several attempts may be required for clutch teeth alignment and shift completion to occur. The preferred method is with the vehicle rolling 3 to 5 km/h (2 to 3 mph). Avoid attempting to engage or disengage 4LO with the vehicle moving faster than 3 to 5 km/h (2 to 3 mph).

4 ALL TIME to 4 LO or 4 LO to 4 ALL TIME (Diesel Models Only)

1. Slow the vehicle to 3 to 5 km/h (2 to 3 mph).
2. Shift transmission into N (Neutral).
3. Shift transfer case into 4LO or ALL TIME as desired (do not hesitate in Neutral).
4. Bring vehicle to a "Full Stop."
5. Shift transmission into D (Drive) or R (Reverse) as desired.

Quadra-Drive System — If Equipped

The optional Quadra-Drive System features three torque transfer couplings. The couplings include Vari-Lok front and rear axles and Quadra-Trac II transfer case. While the transfer case and axle couplings differ in design, their operation is simi-

lar. Follow the Quadra-Trac II transfer case shifting information, preceding this section, for shifting this system.

VARI-LOK FRONT AND REAR AXLES — IF EQUIPPED

The optional Vari-Lok axle is fully automatic and requires no driver input to operate. Under normal driving conditions the unit functions as a standard axle balancing torque evenly between left and right wheels. With a traction difference between left and right wheels the coupling will sense a speed difference. As one wheel begins to spin faster than the other, torque will automatically transfer from the wheel that has less traction to the wheel that has traction.

PARKING BRAKE

To set the parking brake, pull the lever up as firmly as possible. When the parking brake is applied with the ignition ON, the "Brake Warning Light" in the instrument cluster will light.

NOTE:

The instrument cluster "Brake Warning Light" indicates only that the parking brake is applied. It does not indicate the degree of brake application.

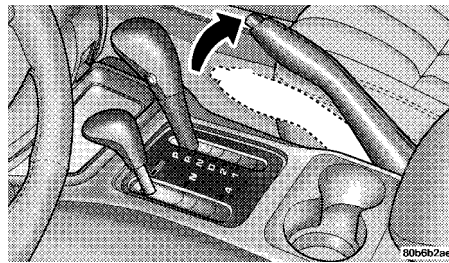

Before leaving the vehicle parked on a hill, you must make sure the parking brake is fully applied and place the gear selector in the P (Park) position. Make certain the transfer case is in gear. Failure to do so may cause the vehicle to roll and cause damage or injury.

When parking on a hill, it is important to set the parking brake before placing the gear selector in P (Park), otherwise the load on the transmission locking mechanism may make it difficult to move the selector out of P (Park).

The parking brake should always be applied when the driver is not in the vehicle.

WARNING!

- Leaving children unattended in a vehicle is dangerous for a number of reasons. A child or others could be injured. Children should be warned not to touch the parking brake or the gear selector lever. Don't leave the keys in the ignition. A child could operate power windows, other controls, or move the vehicle.
- Do not leave children or animals inside parked vehicles in hot weather. Interior heat build up may cause serious injury or death.

To release the parking brake, pull up slightly, press the center button, then lower the lever completely.

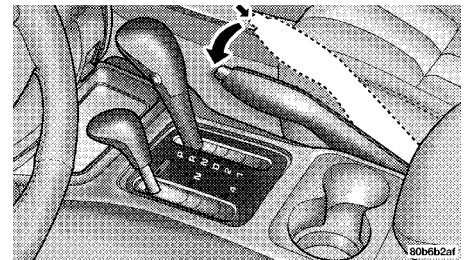

Be sure the parking brake is fully disengaged before driving. Failure to do so can lead to brake failure.

NOTE:

Parking brake adjustment and maintenance should be performed by your authorized dealer.

ANTI-LOCK BRAKE SYSTEM

The Anti-Lock Brake System (ABS) is designed to aid the driver in maintaining vehicle control under adverse braking conditions. The system operates with a separate computer to modulate hydraulic pressure to prevent wheel lock-up and help avoid skidding on slippery surfaces.

All vehicle wheels and tires must be the same size and type and tires must be properly inflated to produce accurate signals for the computer.

WARNING!

Significant over or under inflation of tires, or mixing sizes of tires or wheels on the vehicle can lead to loss of braking effectiveness.

The Anti-Lock Brake System conducts a low-speed self-test at about 20 km/h (12 mph). If you have your foot lightly on the brake while this test is

occurring you may feel slight pedal movement. The movement can be more apparent on ice and snow. This is normal.

The Anti-Lock Brake System pump motor runs during the self-test at 20 km/h (12 mph) and during an ABS stop. The pump motor makes a low humming noise during operation, which is normal.

WARNING!

Pumping of the Anti-Lock Brakes will diminish their effectiveness and may lead to an accident. Pumping makes the stopping distance longer. Just press firmly on your brake pedal when you need to slow down or stop.

CAUTION!

The Anti-Lock Brake System is subject to possible detrimental effects of electronic interference caused by improperly installed aftermarket radios or telephones.

NOTE:

During severe braking conditions, a pulsing sensation may occur and a clicking noise will be heard. This is normal, indicating that the Anti-Lock Brake System is functioning.

WARNING!

To use your brakes and accelerator more safely, follow these tips:

- Do not "ride" the brakes by resting your foot on the pedal. This could overheat the brakes and result in unpredictable braking action, longer stopping distances, or brake damage.
- When descending mountains or hills, repeated braking can cause brake fade with loss of braking control. Avoid repeated heavy braking by downshifting the transmission or locking out overdrive whenever possible.
- Engines may idle at higher speeds during warm-up, which could cause rear wheels to spin and result in loss of vehicle control. Be especially careful while driving on slippery roads, in close-quarter maneuvering, parking or stopping. The Quadra-Trac II transfer case engages four-wheel drive automatically when required.
- Do not drive too fast for road conditions, especially when roads are wet or slushy. A wedge of water can build up between the tire tread and the road. This hydroplaning action can cause loss of traction, braking ability, and control.

- After going through deep water or a car wash, brakes may become wet, resulting in decreased performance and unpredictable braking action. Dry the brakes by gentle, intermittent pedal action while driving at very slow speeds.

ON-ROAD DRIVING TIPS

Utility vehicles have higher ground clearance and a narrower track to make them capable of performing in a wide variety of off-road applications. Specific design characteristics give them a higher center of gravity than ordinary cars.

An advantage of the higher ground clearance is a better view of the road, allowing you to anticipate problems. They are not designed for cornering at the same speeds as conventional 2-wheel drive vehicles any more than low-slung sports cars are designed to perform satisfactorily in off-road conditions. If at all possible, avoid sharp turns or abrupt maneuvers. As with other vehicles of this type, failure to operate this vehicle correctly may result in loss of control or vehicle rollover.

OFF-ROAD DRIVING TIPS

When To Use 4 LO (Low) Range

When off-road driving, shift to 4 LO for additional traction in moving forward or descending a hill, for low-speed pulling power or to improve handling and control on slippery or difficult terrain. Also use

4 LO range on the road in rain, ice, snow, mud or sand to get heavy loads rolling, or whenever "High" range four-wheel drive traction is insufficient.

In Snow, Mud and Sand

In heavy snow, when pulling a load, or for additional control at slower speeds, shift the transmission to a low gear and shift the transfer case to 4 LO if necessary. Don't shift to a lower gear than necessary to maintain headway. Over-revving the engine can spin the wheels and traction will be lost.

Do not downshift on icy or slippery roads, because engine braking may cause skidding and loss of control.

Hill Climbing

Before climbing a steep hill, shift the transmission to a lower gear and shift the transfer case to 4 LO. Use first gear and 4 LO for very steep hills.

If you stall or begin to lose headway while climbing a steep hill, allow your vehicle to come to a stop and immediately apply the brakes. Restart the engine and shift to R (Reverse). Back slowly down the hill allowing the compression braking of the engine and transmission to help regulate your speed. If the brakes are required to control vehicle speed, apply them lightly and avoid locking or skidding the tires.

WARNING!

If the engine stalls or you lose headway or cannot make it to the top of a steep hill or grade, never attempt to turn around. To do so may result in tipping and rolling the vehicle. Always back carefully straight down a hill in R (Reverse) gear. Never back down a hill in N (Neutral) using only the brake.

Remember, never drive diagonally across a hill-always drive straight up or down.

If the wheels start to slip as you approach the crest of a hill, ease off the accelerator and maintain headway by turning the front wheels sharply left and right. This will provide fresh "bite" into the surface and will usually provide traction to complete the climb.

Traction Downhill

Shift the transmission into a low gear and the transfer case to 4 LO range. Let the vehicle go slowly down the hill with all four wheels turning against engine compression drag. This will permit you to control the vehicle speed and direction.

When descending mountains or hills, repeated braking can cause brake fade with loss of braking control. Avoid repeated heavy braking by downshifting the transmission whenever possible.

After Driving Off-Road

Off-road operation puts more stress on your vehicle than does most on-road driving. After going off-road it is always a good idea to check for damage. That way you can get any problems taken care of right away and have your vehicle ready when you need it.

- Completely inspect the underbody of your vehicle. Check tires, body structure, steering, suspension, and exhaust system for damage.
- Check threaded fasteners for looseness, particularly on the chassis, drivetrain components, steering, and suspension. Retighten them, if required, and torque to the values specified in the Service Manual.
- Check for accumulations of plants or brush. These things could be a fire hazard. They might hide damage to fuel lines, brake hoses, axle pinion seals, and propeller shafts.
- After extended operation in mud, sand, water, or similar dirty conditions, have brake rotors, wheels, brake linings, and axle yokes inspected and cleaned as soon as possible.

WARNING!

Abrasive material in any part of the brakes may cause excessive wear or unpredictable braking. You might not have full braking power when you need it to prevent an accident. If you have been operating your vehicle in dirty conditions, get your brakes checked and cleaned as necessary.

- If you experience unusual vibration after driving in mud, slush or similar conditions, check the wheels for impacted material. Impacted material can cause a wheel imbalance and freeing the wheels of it will correct the situation.

FUEL REQUIREMENTS

Your vehicle is designed to meet all emission regulations and provide excellent fuel economy when using high quality unleaded gasoline with a minimum research octane rating of 91.

The vehicle will operate on fuels ranging from regular unleaded having a minimum research octane of 91 to premium unleaded with a minimum research octane of 98.

Over 40 automobile manufacturers around the world have issued and endorsed consistent gasoline specifications (the World Wide Fuel Charter, WWFC) to define fuel properties necessary to deliver enhanced emissions, engine perfor-

mance, and durability for your vehicle. The manufacturer recommends the use of gasolines that meet the WWFC specifications if they are available.

Light spark knock at low engine speeds is not harmful to your engine. However, continued heavy spark knock at high speeds can cause damage and should be reported to your dealer immediately. Engine damage resulting from operating with a heavy spark knock may not be covered by the new vehicle warranty.

Besides using unleaded gasoline with the proper octane rating, gasolines that contain detergents, corrosion and stability additives are recommended. Using gasolines that have these additives may help improve fuel economy, reduce emissions, and maintain vehicle performance.

Poor quality gasoline can cause problems such as hard starting, stalling and stumble. If you experience these problems, try another brand of gasoline before considering service for the vehicle.

Methanol

(Methyl or Wood Alcohol) is used in a variety of concentrations when blended with unleaded gasoline. You may find fuels containing 3% or more methanol along with other alcohols called cosolvents.

Do not use gasolines containing Methanol.

Use of methanol/gasoline blends may result in starting and driveability problems and damage critical fuel system components.

Problems that are the result of using methanol/gasoline blends are not the responsibility of the manufacture and may not be covered by the new vehicle warranty.

Clean Air Gasoline

Many gasolines are now being blended that contribute to cleaner air, especially in those areas where air pollution levels are high. These new blends provide a cleaner burning fuel and some are referred to as "reformulated gasoline."

The manufacture supports these efforts toward cleaner air. You can help by using these blends as they become available.

Materials Added to Fuel

Indiscriminate use of fuel system cleaning agents should be avoided. Many of these materials intended for gum and varnish removal may contain active solvents or similar ingredients. These can harm fuel system gasket and diaphragm materials.

FUEL REQUIREMENTS — DIESEL

Diesel fuels are available from most reputable fuel marketers. We encourage you to use only the best quality fuel with a calculated Cetane Index of 45 or higher. See your authorized dealer or distributor for further information regarding fuels available in your area.

In areas where diesel fuel is below the recommended quality levels (high levels of sulfur and water) it is critical to monitor the fuel filter for contamination and the "Water-In-Fuel Warning Light" in the instrument cluster. Failure to properly service the fuel system for these items can significantly reduce engine life and lead to major engine repair. More frequent service intervals of the fuel filter/water separator unit may be required under these conditions than those shown in "Maintenance Schedule A or B." See your authorized dealer or distributor for specific information.

NOTE:

When the "Water-In-Fuel Warning Light" in the instrument cluster comes on, the fuel filter/water separator assembly must be drained. Refer to "Maintaining Your Vehicle" for the proper procedure

FUEL TANK FILLER CAP (GAS CAP)

WARNING!

To avoid fuel spillage and overfilling, do not "top off" the fuel tank after filling.

The locking fuel cap is located behind the fuel filler door, on the left side of the vehicle. If the fuel cap is lost or damaged, be sure the replacement cap has been designed for use with this vehicle.

CAUTION!

Damage to the fuel system or emission control system could result from using an improper fuel cap. A poorly fitting cap could let impurities into the fuel system.

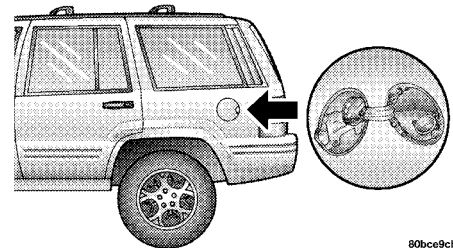

80bce9cb

WARNING!

If you remove the fuel cap too quickly, you could be injured. Gasoline could spray out of the filler neck, and could ignite if there is any spark or flame nearby. This is more possible when the vehicle is hot, as the pressure in the fuel tank is greater then. Remove the fuel cap slowly. Never have any smoking materials lit in or near the vehicle when the cap is being removed or the tank filled.

- Turn off engine.
- Insert the ignition key into the fuel cap and turn the key ¼ turn to the right, then rotate the fuel cap to the left to remove.
- Rotate the ignition key back to the left to remove.
- To replace the cap, insert it into the filler neck and tighten to the right until at least three clicks are heard.
- If your vehicle is equipped with a fuel cap that has a tether strap make sure the tether strap is not caught under the fuel cap.

NOTE:

To avoid overfilling the fuel tank, do not add any fuel after the gas pump automatic shutoff “clicks” for the third time.

WARNING!

- Remove the fuel cap slowly to prevent fuel spray from the filler neck which may cause injury.
- The volatility of some gasolines may cause a buildup of pressure in the fuel tank which may increase while you drive. This pressure can result in a spray of gasoline and/or vapors when the cap is removed from a hot vehicle. Removing the cap slowly allows the pressure to vent and prevents fuel spray.
- Never add fuel when the engine is running.
- Never have any smoking materials lit in or near the vehicle when the fuel cap is removed or the tank filled.

WARNING!

A fire may result if gasoline is pumped into a portable container that is inside of a vehicle, or on a truck bed. You could be burned. Always place fuel containers on the ground while filling.

TIRES AND WHEELS

The factory installed tires on your vehicle are selected to provide the best all around tire performance for normal operation when inflated as recommended.

Your painted or chrome aluminum wheels should be treated as you would treat the finish on your vehicle. Always use a soft non-abrasive cloth with a mild dishwashing soap and water when cleaning your wheels. Never use scouring pads, steel wool, or a bristle brush. Never use cleaners that contain acid, oven cleaners, or any abrasive metal cleaner as they will cause permanent staining and/or corrosion.

Tire Usage

Oversize tires do not provide increased vehicle maximum weight capacity. The use of other sizes may cause interference of suspension and steering travel and may cause tire damage.

Tire Maintenance

New tires, including the spare should be broken in for at least 80 km (50 miles) at speeds under 90 km/h (55 mph). Check tire pressure regularly.

Maintain wheels in balance, and proper front suspension alignment.

Tire Inflation Pressures

The tire pressure should be checked and adjusted at least once every month. Check more often if subject to a wide range of outdoor temperatures, as tire pressures vary with temperature changes.

Inflation pressures specified on the chart are always "Cold Inflation Pressure." Cold inflation pressure is defined as the tire pressure after the vehicle has been idle for at least 3 hours, or driven less than a mile after a 3 hour period. The cold inflation pressure must not exceed the maximum values molded into the tire sidewall.

Cold Tire Pressures	
Tire Size	Pressures
P235/65HR17 BSW	227 kPa (33 psi) [2.275 bar]
P235/65TR17 BSW	227 kPa (33 psi) [2.275 bar]
P235/65HR17 OWL	227 kPa (33 psi) [2.275 bar]
Full Size Spare	227 kPa (33 psi) [2.275 bar]

Tire pressures may increase from 13 to 40 kPa (2 to 6 psi) [0.138 to 0.414 bar] during operation. DO NOT reduce this normal pressure buildup.

Tire Rotation

Tires on the front and rear axles of vehicles operate at different loads and perform different steering, driving, and braking functions. For these reasons, they wear at unequal rates, and develop irregular wear patterns. These effects can be reduced by timely rotation of tires. The benefits of rotation are especially worthwhile with aggressive tread designs such as those on On/Off Road type tires. Rotation will increase tread life, help to maintain mud, snow, and wet traction levels, and contribute to a smooth, quiet ride.

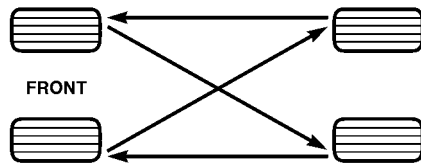

8031e864

Rotation is recommended at 12 000 km (7,500 miles) if you are following Maintenance Schedule "A" and at 5 000 km (3,000 miles) intervals if you are following Maintenance Schedule "B". More frequent rotation is permissible if desired. The reasons for any rapid or unusual wear should be corrected before you rotate the tires.

Alignment and Balance

Tire suspension components of your vehicle should be inspected and aligned when needed, to obtain full tire tread mileage.

Poor suspension alignment may result in:

- fast tire wear
- uneven tire wear (such as feathering and one-sided wear)
- vehicle pull to the right or to the left.
- steering wheel off center

Tires may also cause your vehicle to pull to the left or right. Alignment won't correct this problem. See your dealer for proper diagnosis of the problem.

If your vehicle vibrates, you may have a tire and wheel out of balance. Proper balancing will reduce vibration and avoid tire cupping and spotty wear. Improper alignment will not normally cause vehicle vibration.

Replacement Tires

The tires on your new vehicle provide a balance of many characteristics. They should be inspected regularly for wear and correct inflation pressure. The manufacturer strongly recommends that you use tires equivalent to the originals in quality and performance when replacement is needed (see section on tread wear indicators). Failure to use equivalent replacement tires may adversely affect the safety, handling and ride of your vehicle. We recommend that you contact your original equipment tire dealer on any questions you may have on tire specifications or capability.

WARNING!

- Never use a tire smaller than the minimum tire size listed on your vehicle's tire placard. Using a smaller tire could result in tire overloading and failure.
- Failure to equip your vehicle with tires having adequate speed capability can result in sudden tire failure and loss of vehicle control.
- Overloading your tires is dangerous. Like underinflation, overloading can cause tire failure. Use tires of the recommended load capacity for your vehicle — never overload them.
- Do not use a tire, wheel size or rating other than that specified for your vehicle. Some combinations of unapproved tires and wheels may change suspension dimensions and performance characteristics, resulting in changes to steering, handling, and stress to steering and suspension components. You could lose control and have an accident resulting in serious injury or death. Use only the tire and wheel sizes with load ratings approved for your vehicle.

CAUTION!

Replacing original tires with tires of a different size may result in false speedometer and odometer readings. This can also affect vehicle performance and can do potential damage to the driveline. Check with your dealer before replacing tires with a different size.

Tire Chains or Traction Devices

Certain models have sufficient tire-to-body clearance to allow use of tire chains. **Install chains on rear tires only.** Follow these recommendations to guard against damage and excessive tire and chain wear:

- Do not install tire chains or traction devices on vehicles with larger than P225/75R16 size tires. These tires are too large for sufficient body clearance with chains or other traction devices.
- Use SAE class "S" tire chains or traction devices only.

- Follow tire chain manufacturer's instructions for mounting chains.
- Install chains snugly and tighten after 1 km (1/2 mile) of driving.
- **Do not** exceed 50 km/h (35 mph), unless otherwise specified by the chain manufacturer.
- Drive cautiously, avoiding large bumps, potholes and extreme driving maneuvers.

Tire Spinning

When stuck in mud, sand, snow, or ice conditions, do not spin the wheels faster than 56 km/h (35 mph).

Treadwear Indicators

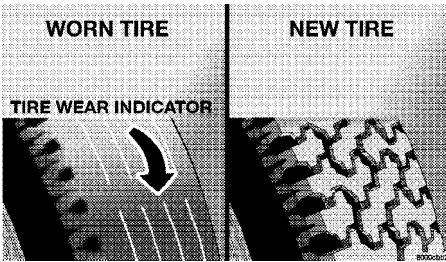

These indicators are narrow strips 1.6 mm (1/16 inch) thick and are found in the tread pattern grooves.

When the tread pattern is worn down to these treadwear indicators, the tires should be replaced.

Overloading your vehicle, long trips in very hot weather, and driving on bad roads may result in greater wear.

TRAILER TOWING

In this section you will find information on limits to the type of towing you can reasonably do with your vehicle, and you will find safety tips. Before towing a trailer carefully review this information to tow your load as efficiently and safely as possible.

To maintain warranty coverage, follow the requirements and recommendations in this manual concerning vehicles used for trailer towing.

Perform maintenance services as prescribed in the "Maintenance Schedule" booklet. When your vehicle is used for trailer towing, never exceed the Gross Axle Weight Rating (GAWR) by the addition of:

- The tongue weight of the trailer.
- The weight of any other type of cargo or equipment put in or on your vehicle.

WARNING!

Improper towing can lead to an injury accident. Follow these guidelines to make your trailer towing as safe as possible:

- Be sure a trailer is loaded heavier in front, about 4% of Gross Trailer Weight (GTW). Loads balanced over the wheels or heavier in the rear cause the trailer to sway **severely** side to side which will cause loss of control of the vehicle and trailer. Failure to load trailers heavier in front is the cause of many trailer related accidents.
- Do **not** interconnect the hydraulic brake system of your vehicle with that of the trailer. This could cause inadequate braking and possible personal injury.
- **Trailer brakes are required for trailers in excess of 750 kg. (1,653 lbs.).**
- Do **not** connect a trailer lighting system directly to the lighting system of your vehicle. Use an approved trailer wiring harness. Failure to do so could damage the vehicle electrical system and/or result in personal injury.

- When hauling cargo or towing a trailer, **do not** overload your vehicle or trailer. Overloading can cause a loss of control, poor performance or damage to brakes, axle, engine, transmission, steering, suspension, body structure or tires.
- Make certain that the load is secured in the trailer and will not shift during travel.
- It is recommended that **any** hitches installed on your vehicle be factory installed, or installed by a dealer using factory approved parts. Factory approved parts are specifically engineered with your vehicle's performance in mind, including the possibility that it will be involved in an accident. Other hitches may not have been so engineered. Vehicle performance, including vehicle damage in an accident situation, may therefore be different.
- If trailer towing is required and your vehicle is not equipped with a trailer tow package, the Mopar® accessory towing harnesses are the only approved method to provide for trailer lights. These harnesses are designed to provide current to the trailer lights but bypass the module designed to monitor tail lights. Refer to the package instructions for details.

Trailer and Tongue Weight

Gross Trailer Weight (GTW) means the weight of the trailer plus the weight of all cargo, consumables and equipment loaded on the trailer when in actual underway towing condition. The best way to measure GTW is to put your fully loaded trailer on a vehicle scale. The entire weight of the trailer must be supported by the scale.

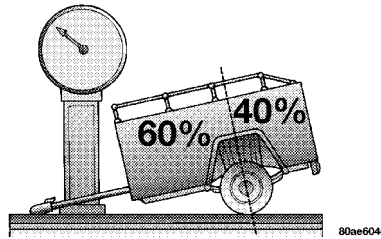

Distribute the load in the trailer so that the trailer tongue weight is 4% of the Gross Trailer Weight and not over 140 kg. (309 lbs.).

Minimum Vehicle Requirements for Trailer Towing

NOTE:

If you tow a trailer frequently, especially in hilly country or when the outdoor temperature is high, we recommend that you do one or both of the following:

- Change the transmission fluid at 19 000 km (12,000 mile) intervals.

CAUTION!

When pulling a heavy load or driving a fully loaded vehicle use a premium unleaded fuel to help prevent spark knock. If spark knock persists, lighten the load. Otherwise, engine piston damage may result.

6

WHAT TO DO IN EMERGENCIES

• HAZARD WARNING FLASHERS	88
• IF YOUR ENGINE OVERHEATS	88
• CHANGING A FLAT TIRE	88
• Jack And Lug Wrench Locations	88
• Spare Tire Location	89
• Tire Changing Procedure	90
• JUMP STARTING PROCEDURE	91
• EMERGENCY TOW HOOKS — IF EQUIPPED	92

HAZARD WARNING FLASHERS

Your vehicle's hazard warning flasher is an emergency warning system. When you activate it, all front and rear directional signals will flash intermittently. Use it when your vehicle is disabled on or near the road. It warns other drivers to steer clear of you and your vehicle. This is an emergency warning system, not to be used when the vehicle is in motion.

To activate the warning flasher, push down on the button on top of the steering column until it latches. To turn the warning flasher off, push down again to unlatch the button.

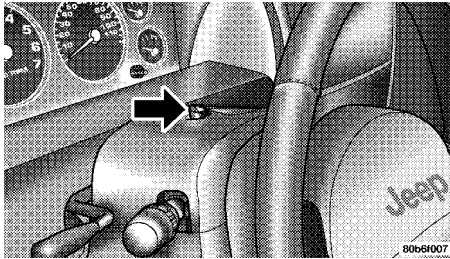

NOTE:

With extended use, the flasher may run down your battery.

IF YOUR ENGINE OVERHEATS

In any of the following situations, you can reduce the potential for overheating by taking the appropriate action.

- On the highways — Slow down.
- In city traffic — While stopped, put transmission in N (Neutral), but do not increase engine idle speed.

NOTE:

There are steps that you can take to slow down an impending overheating condition. If your air conditioner is on, turn it off. The air conditioning system adds heat to the engine cooling system and turning off the A/C removes this heat. You can also turn the Temperature Control to maximum heat, the Mode Control to floor, and the Fan Control to High. This allows the heater core to act as a supplement to the radiator and aids in removing heat from the engine cooling system.

CAUTION!

Driving with a hot cooling system could damage your vehicle. If the temperature gauge reads "H", pull over and stop the vehicle. Idle the vehicle with the air conditioner turned off until the pointer drops back into the normal range. If the pointer remains on the "H", and you hear continuous chimes, turn the engine off immediately, and call for service.

CHANGING A FLAT TIRE

Jack And Lug Wrench Locations

The three piece tool set, consisting of two snap-together extensions that operate the jack and a wheel wrench that also is used as a crank for the jack, is stored under the right rear seat. The screw-type jack is located under the spare tire in the cargo compartment.

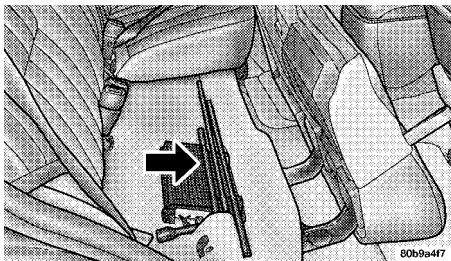

WARNING!
Always store the jack, lug wrench and spare, flat or damaged tire securely in the proper place. Never leave them loose in the vehicle where they could become dangerous projectiles during a quick stop or collision.

WARNING!
To avoid injury from using the jack, follow these important tips:

- Do not start the engine while the vehicle is on the jack, because engine vibration or wheel movement can cause the vehicle to slip off the jack.
- Do not get under vehicle while it is on the jack. The vehicle could slide off, injuring anyone beneath it. Passengers should not remain in the vehicle when you are changing a tire.

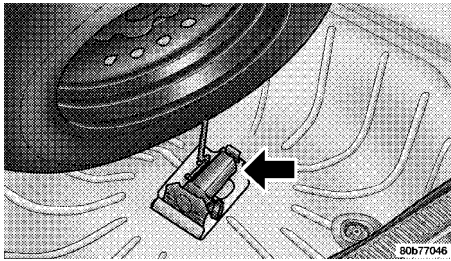

CAUTION!
The jack is for changing wheels on this vehicle only. Place the jack under the axle only. Never use your vehicle jack on the bumpers, sills or underbody of your vehicle. Damage may result. Locate your vehicle jack only under an axle in the positions shown for Tire Changing Procedure.

Spare Tire Location

To Remove the Spare Tire

1. Open the liftgate.
2. Lift the cover on the rear compartment floor.
3. Remove the nut and tire.

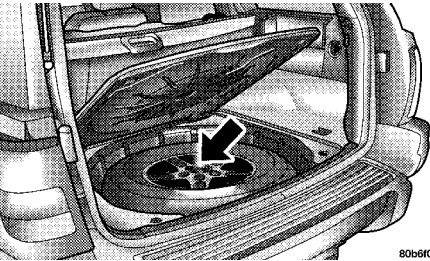

To Replace the Spare Tire

1. Replace the tire into the rear compartment:
 - a. replace the hold-down nut.
 - b. lower the rear compartment cover
2. Your vehicle is equipped with a conventional spare tire. Maintain the conventional spare tire pressure at 227 kPa (33 psi).

Tire Changing Procedure

Preparation

WARNING!

You can be injured or killed if you try to change a wheel too close to moving traffic. Pull far enough off the road to avoid being hit when operating the jack or changing the wheel.

- Park on a firm, level surface well off the road to provide ample work space. Place transmission in P (Park) and stop the engine. Set the parking brake firmly and activate the hazard warning flasher.

Get everyone out of the vehicle before you jack it up. If the jack should fall, someone in the vehicle could be hurt.

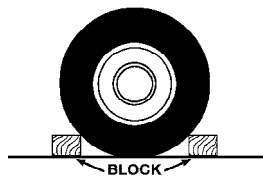

- Block the front and rear of the diagonally opposite tire. For example, if the right front tire is being changed, block the left rear wheel.

Instructions

1. Remove the spare tire, jack and tools from their stored location.
2. Loosen the lug nuts one-half turn to the left.
3. Locate the jack as shown. For the front axle (A), place it under the axle near the wheel to be changed. For the rear axle (B), place it under the axle as shown. Position the jack handle on the jack.

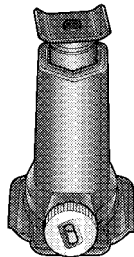

8069a-419

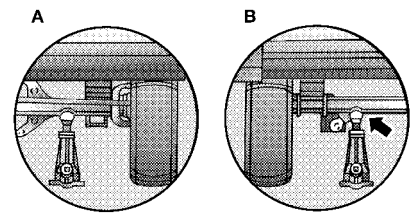

801666.2

4. Raise the vehicle by turning the jack handle to the right until the tire clears the ground.

WARNING!

Raising the vehicle higher than necessary can make the vehicle less stable and cause an accident. It could slip off the jack and hurt someone near it. Raise the vehicle only enough to remove the tire.

5. Remove the lug nuts and wheel.
6. Position the spare wheel/tire on the vehicle and install the lug nuts with the cone-shaped end toward the wheel. Lightly tighten the nuts until they are equally snug, using a crisscross pattern. To avoid the risk of forcing the vehicle off the jack, do not tighten the nuts fully until the vehicle has been lowered.

7. Lower the vehicle and remove the jack and wheel blocks.

8. Tighten the lug nuts securely in a crisscross pattern. Have an authorized service technician check that the torque is 115-156 N·m (85-115 ft.lbs.) as soon as possible.

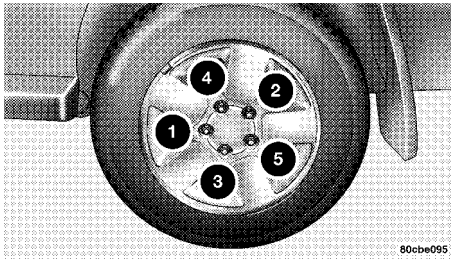

9. Secure the jack, lug wrench, jack handle and tire in the proper locations.

WARNING!

A loose tire or jack thrown forward in a collision or hard stop could injure someone in the vehicle. Always stow the jack parts and the extra tire and wheel in the places provided.

WARNING!

Carefully follow these tire changing warnings to help prevent personal injury or damage to your vehicle:

- Always park on a firm, level surface as far from the edge of the roadway as possible before raising the vehicle.
- Block the wheel diagonally opposite the wheel to be raised.
- Apply the parking brake firmly before jacking.
- Never start the engine with the vehicle on a jack.
- Do not let anyone sit in the vehicle when it is on a jack.
- Do not get under the vehicle when it is on a jack.
- Only use the jack in the positions indicated.
- If working on or near a roadway, be extremely careful of motor traffic.

JUMP STARTING PROCEDURE

NOTE:

Check the test indicator on top of battery for battery fluid level. If the indicator is clear, the level is low. Add water to the proper level and reinstall the vent caps before attempting to jump start the vehicle.

1. Wear eye protection and remove any metal jewelry such as watch bands or bracelets that might make an unintended electrical contact.
2. When boost is provided by a battery in another vehicle, park that vehicle within booster cable reach but without letting the vehicles touch. Set the parking brake, place the transmission in P (Park), and turn the ignition to OFF for both vehicles.
3. Turn off the heater, radio and all unnecessary electrical loads.
4. Connect one end of a jumper cable to the positive terminal of the discharged battery. Connect the other end of the same cable to the positive terminal of the booster battery.
5. Connect the other cable, first to the negative terminal of the booster battery and then connect the other end to a non-paint metal surface on the engine of the vehicle with the discharged battery. Make sure you have a good contact on the engine.

6. Start the engine in the vehicle which has the booster battery, let the engine idle a few minutes, then start the engine in the vehicle with the discharged battery.

7. When removing the jumper cables, reverse the above sequence exactly. Be careful of the moving belts and fan.

NOTE:

To start the vehicle following connection of a booster battery, the Security Alarm System must first be disabled by cycling a front door key cylinder or by using the keyless entry transmitter.

WARNING!

Jump starting can be dangerous. To avoid personal injury or damage to electrical components in vehicle, observe the following warnings:

- Battery fluid is a corrosive acid solution and can burn or even blind you. Don't allow battery fluid to contact your eyes, skin, or clothing. Don't lean over a battery when attaching clamps. If acid splashes in eyes or on skin, flush the area immediately with large amounts of water.

- Do not use a booster battery or any other booster source that has a greater than 12-volt system, i.e., do not use a 24-volt power source.
- Never attempt to jump start a discharged battery that is frozen, because it could rupture or explode during jump starting.
- Be sure your vehicle is not touching the jump start vehicle.
- Observe all Battery Warnings in Section 7 of this manual, while jump starting your vehicle.

WARNING!

Do not attempt to push or tow your vehicle to get it started. Unburned fuel could enter the catalytic converter and, once the engine has started, ignite and damage the converter and vehicle.

EMERGENCY TOW HOOKS — IF EQUIPPED

If your vehicle is equipped with tow hooks, they will be mounted in the front and the rear of the vehicle.

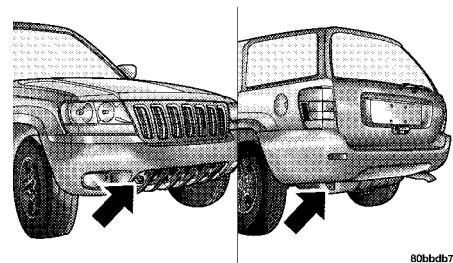

80bbdb71

CAUTION!

Tow hooks are for emergency use only, to rescue a vehicle stranded off road. Do not use tow hooks for tow truck hookup or highway towing. You could damage your vehicle.

WARNING!

Stand clear of vehicles when pulling with tow hooks. Tow straps and chains may break, causing serious injury.

MAINTAINING YOUR VEHICLE

• 2.7L DIESEL ENGINE	95
• 4.0L ENGINE	96
• 4.7L/4.7L HO ENGINES	97
• ONBOARD DIAGNOSTIC SYSTEM (OBD)	98
• REPLACEMENT PARTS	98
• MAINTENANCE PROCEDURES	98
• Engine Oil	98
• Drive Belts - Check Condition and Tension	100
• Spark Plugs — Gasoline Engines	100
• Engine Air Cleaner Filter	100
• Fuel Filter — Gasoline Engines	100
• Catalytic Converter	100
• Battery	101
• Air Conditioner	102
• Power Steering — Fluid Check	102
• Driveline And Steering Component Lubrication	103
• Body Lubrication	103
• Windshield Wiper Blades	103
• Windshield Washers — Front and Rear	103

- Exhaust System 104
- Cooling System 104
- Hoses and Vacuum/Vapor Harnesses 106
- Brake System 106
- Automatic Transmission 108
- Transfer Case 110
- Front/Rear Axle Fluid 110
- Appearance Care And Protection From Corrosion 110
- FUSE PANEL 111
 - Interior Fuses 111
 - Underhood Fuses (Power Distribution Center) 113
- REPLACEMENT BULBS 113
- FLUID CAPACITIES 114
- RECOMMENDED FLUIDS, LUBRICANTS AND GENUINE PARTS 114
 - Engine 114
 - Chassis 115
 - Body 115

2.7L DIESEL ENGINE

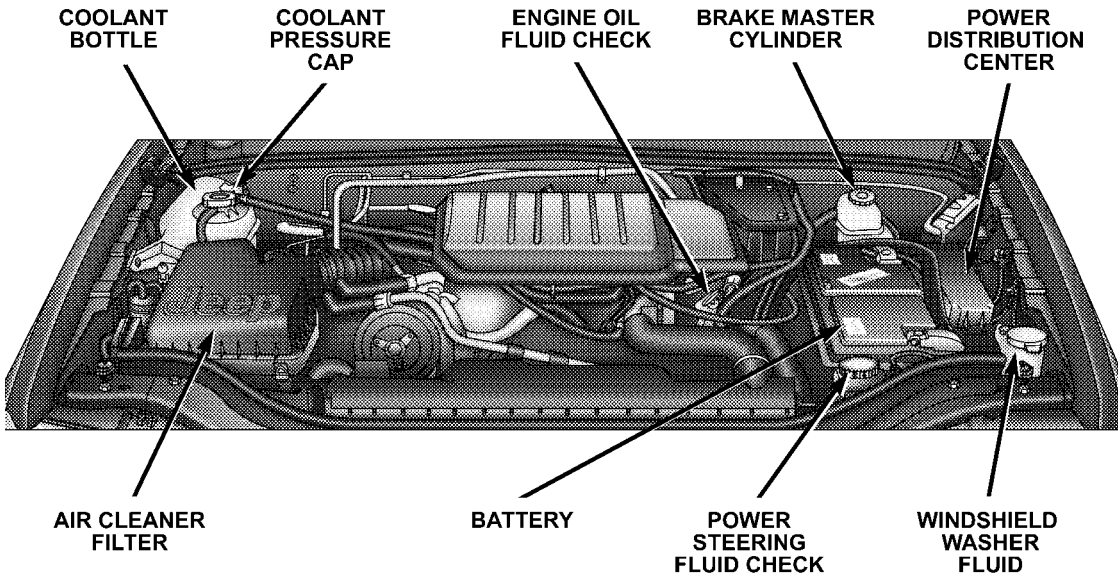

80df84c2

4.0L ENGINE

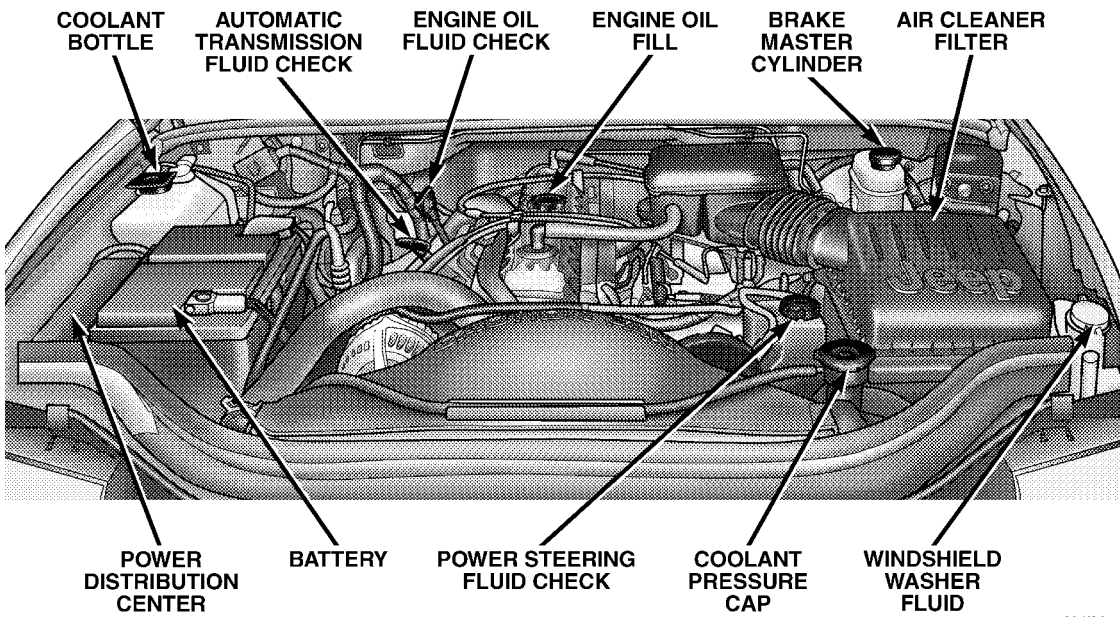

80df94ca

4.7L/4.7L HO ENGINES

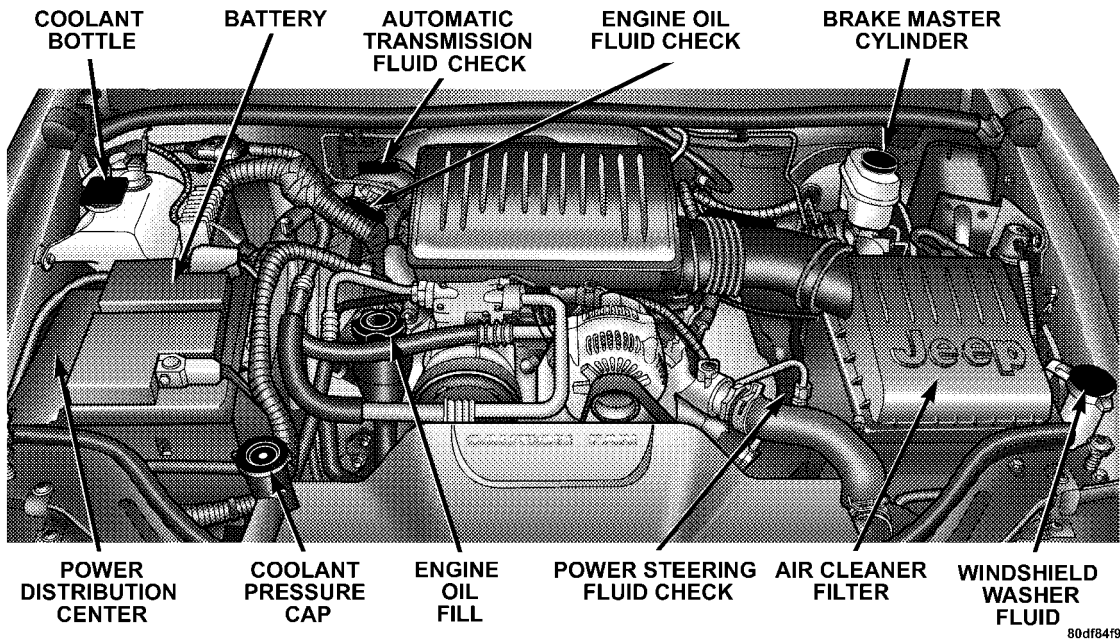

ONBOARD DIAGNOSTIC SYSTEM (OBD)

Your vehicle is equipped with a sophisticated onboard diagnostic system called OBD. This system monitors the performance of the emissions, engine, and automatic transmission control systems. When these systems are operating properly, your vehicle will provide excellent performance and fuel economy, as well as engine emissions well within current government regulations.

If any of these systems require service, the OBD system will turn on the "Malfunction Indicator Light." It will also store diagnostic codes and other information to assist your service technician in making repairs. Although your vehicle will usually be driveable and not need towing, see your authorized dealer for service as soon as possible.

CAUTION!

Prolonged driving with the light on could cause further damage to the emission control system. It could also affect fuel economy and driveability.

If the light is flashing, severe catalytic converter damage and power loss will soon occur. Immediate service is required.

REPLACEMENT PARTS

Use of genuine Mopar® parts for normal/scheduled maintenance and repairs is highly recommended to insure the designed performance. Damage or failures caused by the use of non-Mopar® parts for maintenance and repairs will not be covered by the manufacturer's warranty.

MAINTENANCE PROCEDURES

Engine Oil

Checking Oil Level — Gasoline Engines

To assure proper engine lubrication, the engine oil must be maintained at the correct level. Check the oil level at regular intervals, such as every fuel stop.

The best time to check the engine oil level is about 5 minutes after a fully warmed engine is shut off or before starting the engine after it has sat overnight.

Checking the oil while the vehicle is on level ground will improve the accuracy of the oil level readings. Maintain the oil level between the MIN and MAX or ADD and SAFE markings on the dipstick. Adding 0.95L (1 U.S. Quart) of oil when the reading is at the MIN mark will result in a MAX reading on these engines.

Checking Engine Oil — Diesel Engines

Check the oil level at every fuel fill, with the engine on level ground. If the engine is warm, allow time for the oil to drain into the crankcase before checking the level. The level should be between the ADD and FULL marks on the dipstick.

Oil gets thicker at low temperatures, which will slow down engine cranking speeds when starting. Diesel engines require faster cranking speeds, so be certain to use the proper oil viscosity.

CAUTION!

- When the oil level is at the ADD mark, adding 0.95L (1 U.S. Quart) will bring the level to FULL.
- A diesel engine may consume more oil than a gasoline engine when new. If engine oil falls below the ADD mark, immediately add oil, or engine damage may occur.
- DO NOT OVERFILL. Engine damage may occur.

Change Engine Oil

Road conditions as well as your kind of driving affect the interval at which your oil should be changed.

If any of these apply to you, then change your engine oil every 5 000 km (3,000 miles) or 3 months, whichever comes first and follow the maintenance recommendations in "Maintenance Schedule B."

- Day or night temperatures are below 0°C (32°F)
- Stop and go driving
- Extensive engine idling
- Driving in dusty conditions
- Short trips of less than 16 km (10 miles)
- More than 50% of your driving is at sustained high speeds during hot weather, above 32°C (90°F)
- Trailer towing
- Taxi, Police, or delivery service (Commercial Service)
- Off-road or desert operation

If none of these apply to you, then change your engine oil every 12 000 km (7,500 miles) or 6 months, whichever comes first.

Engine Oil Selection — Gasoline Engines

For best performance and maximum protection for all engines under all types of operation, you should only select engine oils that meet the oil quality certification and viscosity requirements as follows:

American Petroleum Institute (API) Engine Oil Identification Symbol



This symbol on the front of an oil container means that the oil has been certified by the American Petroleum Institute (API) to meet all the lubrication requirements specified by the manufacturer.

Engine Oil Viscosity Chart

The proper SAE viscosity grade of engine oil should be selected based on the following recommendation and be within the operating temperature shown in the engine oil viscosity chart.

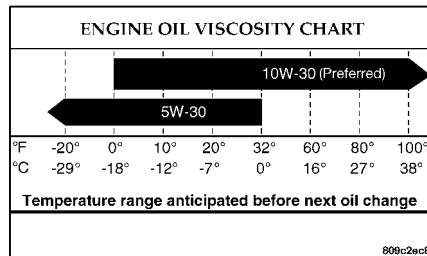

4.0L Engines

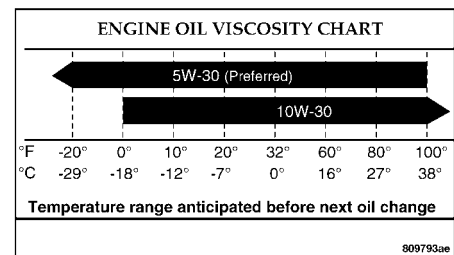

4.7L/4.7L HO Engines

Engine Oil Selection — Diesel Engines

Use only the manufacturer's recommended fluid. Refer to Recommended Fluids, Lubricants, and Genuine Parts for correct fluid type.

Materials Added to Engine Oils

The manufacturer **does not recommend** the addition of any additive to the specified engine oil.

Disposing of Used Engine Oil

Care should be taken in disposing of the used engine oil from your vehicle. Used oil, indiscriminately discarded, can present a problem to the environment. Contact your authorized dealer, or governmental agency for advice on how and where they can be safely discarded in your area.

Engine Oil Filter

The engine oil filter should be replaced with a new filter at every oil change.

Engine Oil Filter Selection

All of the manufacturer's engines have a full-flow type disposable oil filter. Use a filter of this type for replacement. The quality of replacement filters varies considerably. Only high quality filters should be used to assure most efficient service. Mopar® engine oil filters are high quality oil filters and are recommended.

Drive Belts - Check Condition and Tension

At the mileage shown in the appropriate "Maintenance Schedule," check all drive belts for condition and proper tension. Improper belt tension can cause belt slippage and failure.

Inspect the drive belt for evidence of cuts, cracks, or glazing and replace them if there is any sign of damage which could result in belt failure. If adjustment is required, adjust the belts according to the specifications and procedures shown in the Service Manual (if available) or visit your authorized dealer.

Special tools are required to properly measure tension and to restore belt tension to factory specifications. Also, check belt routing to make sure there is no interference between the belts and other engine components.

Spark Plugs — Gasoline Engines

Spark plugs must fire properly to assure engine performance and emission control. New spark plugs should be installed at the specified mileage. The entire set should be replaced if there is any malfunction due to a faulty spark plug. Refer to the "Vehicle Emission Control Information" label in the engine compartment for spark plug information.

Engine Air Cleaner Filter

Under normal driving conditions, replace the air filter at the intervals shown on "Maintenance Schedule A." If, however, you drive the vehicle frequently under dusty or severe conditions, the filter element should be inspected periodically and replaced if necessary at the intervals shown on "Maintenance Schedule B."

WARNING!

The air cleaner can provide protection in the case of engine backfire. Do not remove the air cleaner unless it is necessary for repair or maintenance. Make sure that no one is near the engine compartment before starting the vehicle with the air cleaner removed. Failure to do so can result in serious personal injury.

Fuel Filter — Gasoline Engines

A plugged fuel filter can cause hard starting or limit the speed at which a vehicle can be driven. Should an excessive amount of dirt accumulate in the fuel tank, frequent replacement of the fuel filter which is mounted in the fuel tank may be necessary.

Catalytic Converter

The catalytic converter requires the use of unleaded fuel only. Leaded gasoline will destroy the effectiveness of the converter as an emission control device.

Under normal operating conditions, the catalytic converter will not require maintenance. However, it is important to keep the engine properly tuned to assure proper catalyst operation and prevent possible catalyst damage.

CAUTION!

Damage to the catalytic converter can result if your vehicle is not kept in proper operating condition. In the event of engine malfunction, particularly involving engine misfire or other apparent loss of performance, have your vehicle serviced promptly. Continued operation of your vehicle with a severe malfunction could cause the converter to overheat, resulting in possible damage to the converter and vehicle.

WARNING!

A hot exhaust system can start a fire if you park over materials that can burn. Such materials might be grass or leaves coming into contact with your exhaust system. Do not park or operate your vehicle in areas where your exhaust system can contact anything that can burn.

In unusual situations involving grossly malfunctioning engine operation, a scorching odor may suggest severe and abnormal catalyst overheating. If this occurs, stop the vehicle, turn off the engine and allow it to cool. Service, including a tune up to manufacturer's specifications, should be obtained immediately.

To minimize the possibility of catalytic converter damage:

- Do not shut off the engine or interrupt the ignition when the transmission is in gear and the vehicle is in motion.
- Do not try to start the engine by pushing or towing the vehicle.
- Do not idle the engine with any spark plug wires disconnected or removed, such as when diagnostic testing.

- Do not idle the engine for prolonged periods during very rough idle or malfunctioning operating conditions.
- Do not allow vehicle to run out of fuel.

NOTE:

Intentional tampering with emissions control systems can result in civil penalties being assessed against you.

Battery

The low-maintenance battery may require the addition of water at intervals depending on vehicle usage. In temperatures up to 32°C (90°F), check the battery fluid level at least every 12 months or 24 000 km (15,000 miles). At higher temperatures, check more often. For severe service vehicles, check at 12 000 km (7,500 miles).

WARNING!

Do not charge a battery or jump start a vehicle with a clear battery charge indicator. If the battery charge indicator is clear, the fluid in the battery is low (add distilled water). Charging a battery or jump starting a vehicle with a clear battery charge indicator could cause serious injury.

Keep the battery terminals clean and free from corrosion by cleaning them periodically with a solution of baking soda and water.

CAUTION!

Keep battery fluid and any deposits removed from the battery connections away from paint, sheet metal and plastics. Damage to these materials could result.

WARNING!

Battery posts, terminals, and related accessories contain lead and lead compounds. Always wash hands after handling the battery.

WARNING!

Handled improperly, batteries can be dangerous. Follow these precautions when servicing your battery:

- Use extreme care when servicing the battery. Battery fluid contains sulfuric acid and must be kept from the eyes and skin. Safety glasses, rubber gloves and protective clothing are recommended. If acid contacts eyes or skin, flush immediately with large amounts of water. Get emergency medical attention immediately.

- Batteries produce hydrogen gas and can explode and cause serious bodily injury. Don't smoke while checking or servicing battery. Keep open flames and sparks away from the battery filler caps.
- To avoid a short circuit which could cause injury, never allow tools or metal objects to contact the battery posts and vehicle at the same time. Also, disconnect the negative battery cable when checking or servicing the battery.
- Always keep battery fluid away from children and pets.
- Do not store the battery where there is a likelihood of open fire, sparks, or accessibility to children.
- Refer to "Jump Starting Procedure" in Section 6 for other battery guidelines.

Air Conditioner

For best possible performance, your air conditioner should be checked by an authorized dealer at the start of each warm weather season. This service should include cleaning of the condenser fins and a system performance check. Drive belt tension should also be checked at this time.

WARNING!

- Use only refrigerants approved by the manufacturer for your air conditioning system. Some unapproved refrigerants are flammable and can explode, injuring you. Other unapproved refrigerants can cause the system to fail, requiring costly repairs.
- Never add air conditioning refrigerant to correct a non-cooling problem unless pressure gauges are connected to the system by a certified technician. Lack of cooling could be due to a restriction and adding refrigerant may cause a dangerous pressure rise and you could be injured.

Refrigerant Recovery and Recycling

The air conditioning system of your vehicle contains R-134a, a refrigerant that does not deplete the ozone layer in the upper atmosphere. The manufacturer recommends that air conditioning service be done by facilities using refrigerant recycling and recovery equipment that meets SAE standard J1991.

Power Steering — Fluid Check

WARNING!

Fluid level should be checked with the engine off to prevent injury from moving parts and to ensure accurate fluid level reading. Do not overfill. Use only the manufacturer's recommended fluid. Refer to Recommended Fluids, Lubricants, and Genuine Parts for correct fluid type.

During scheduled maintenance, check the power steering fluid level at the power steering fluid reservoir.

Before removing the reservoir cap, wipe the outside of the cap and reservoir so that no dirt can fall into the reservoir.

Fluid level should be maintained at the proper level indicated on the side of the reservoir. If necessary, add fluid to restore to the proper indicated level. With a clean cloth, wipe any spilled fluid from all surfaces. Refer to Recommended Fluids, Lubricants, and Genuine Parts for correct fluid type.

Driveline And Steering Component Lubrication

U-joints (cardan joints) are sealed and do not require lubrication. Prop shafts, yokes, ball joints and other driveline and steering components may be provided with grease fittings for lubrication. Lubrication of these components at the intervals specified in the appropriate "Maintenance Schedule" in Section 8 is very important, particularly if your vehicle is subjected to off-road or other heavy-duty use. See your authorized dealer for complete service information.

Body Lubrication

Locks and all body pivot points, including such items as seat tracks, doors, tailgate and hood hinges, should be lubricated periodically to assure quiet, easy operation and to protect against rust and wear. Prior to the application of any lubricant, the parts concerned should be wiped clean to remove dust and grit; after lubricating excess oil and grease should be removed. Particular attention should also be given to hood latching components to insure proper function. When performing other underhood services, the hood latch, release mechanism and safety catch should be cleaned and lubricated.

The external lock cylinders should be lubricated twice a year, preferably in the fall and spring. Apply a small amount of a high quality lubricant such as Mopar® Lock Cylinder Lubricant directly into the lock cylinder.

Windshield Wiper Blades

The rubber edges of the wiper blades and the windshield should be cleaned periodically with a sponge or soft cloth and a mild nonabrasive cleaner to remove accumulations of salt or road film.

Operation of the wipers on dry glass for long periods may cause deterioration of the wiper blades. Always use washer fluid when using the wipers to remove salt or dirt from a dry windshield.

Avoid using the wiper blades to wipe frost or ice from the windshield. Keep the blade rubber out of contact with petroleum products such as engine oil, gasoline, etc.

Windshield Washers — Front and Rear

On vehicles equipped with a Vehicle Information Center, the low washer fluid level will be indicated. When the sensor detects a low fluid level, the windshield will light on the vehicle graphic outline and the "Washer Fluid Low" message will be displayed.

WARNING!

Commercially available windshield washer solvents are flammable. They could ignite and burn you. Care must be exercised when filling or working around the washer solution.

Exhaust System

The best protection against carbon monoxide entry into the vehicle body is a properly maintained engine exhaust system.

Whenever a change is noticed in the sound of the exhaust system, when exhaust fumes can be detected inside the vehicle, or when the underside or rear of the vehicle is damaged, have an authorized technician inspect the complete exhaust system and adjacent body areas for broken, damaged, deteriorated, or mispositioned parts. Open seams or loose connections could permit exhaust fumes to seep into the passenger compartment. In addition, inspect the exhaust system each time the vehicle is raised for lubrication or oil change. Replace as required.

Cooling System

WARNING!

You or others can be badly burned by hot coolant or steam from your radiator. If you see or hear steam coming from under the hood, do not open the hood until the radiator has had time to cool. Never try to open a cooling system pressure cap when the radiator or coolant bottle is hot.

Coolant Checks

Check coolant protection every 12 months (before the onset of freezing weather, where applicable). If coolant is dirty or rusty in appearance, the system should be drained, flushed, and refilled with fresh coolant.

Check the front of the radiator for any accumulation of bugs, leaves, etc. Clean the radiator by gently spraying water from a garden hose at the back of the core.

Check the engine cooling system hoses for condition and tightness of connection. Inspect the entire system for leaks. Any hoses that show cuts or severe abrasion must be replaced.

Cooling System — Drain, Flush, and Refill

At the intervals shown in the appropriate "Maintenance Schedule," the system should be drained, flushed, and refilled.

If the solution is dirty and contains a considerable amount of sediment, clean and flush with reliable cooling system cleaner. Follow with a thorough rinsing to remove all deposits and chemicals.

Selection of Coolant

Use only the manufacturer's recommended coolant, refer to Recommended Fluids, Lubricants, and Genuine Parts for correct coolant type.

CAUTION!

Mixing of coolants other than the specified HOAT coolant may result in decreased corrosion protection and engine damage that may not be covered under the new vehicle warranty. If a non-HOAT coolant is introduced into the cooling system in an emergency, it should be replaced with the specified coolant as soon as possible.

Do not use plain water alone or alcohol base antifreeze products. Do not use additional rust inhibitors or antirust products, as they may not be compatible with the radiator coolant and may plug the radiator.

This vehicle has not been designed for use with Propylene Glycol based coolants. Use of Propylene Glycol base coolants is not recommended.

Adding Coolant

When adding coolant, a minimum solution of 50% recommended HOAT ethylene glycol coolant in water should be used. Use higher concentrations (not to exceed 70%) if temperatures below -38°C (-37°F) are anticipated.

Use only high purity water such as distilled or deionized water when mixing the water/antifreeze solution. The use of lower quality water will reduce the amount of corrosion protection in the engine cooling system.

Please note that it is the owner's responsibility to maintain the proper level of protection against freezing according to the temperatures occurring in the area where the vehicle is operated.

Coolant Pressure Cap

The cap must be fully tightened to prevent loss of coolant, and to ensure that coolant will return to the radiator from the coolant reserve tank.

The cap should be inspected and cleaned if there is any accumulation of foreign material on the sealing surfaces.

WARNING!

The warning words **DO NOT OPEN HOT** on the cooling system pressure cap are a safety precaution. Never add coolant when the engine is overheated. Do not loosen or remove the cap to cool an overheated engine. Heat causes pressure to build up in the cooling system. To prevent scalding or injury, do not remove the pressure cap while the system is hot or under pressure.

Disposal of Used Engine Coolant

Used ethylene glycol-based engine coolant is a regulated substance requiring proper disposal. Check with your local authorities to determine the disposal rules for your community. Do not store ethylene glycol-based engine coolant in open containers or allow it to remain in puddles on the ground. Prevent ingestion by animals and children. If ingested by a child, contact a physician immediately. Clean up any ground spills immediately.

Checking Coolant Level — Gasoline Engines

Check the coolant level at least once a month or more often in hot weather. Check the level when the engine is at normal operating temperature. Check the coolant level only in the coolant recovery

ery bottle. The coolant level must be between the FULL and the ADD mark on the bottle.

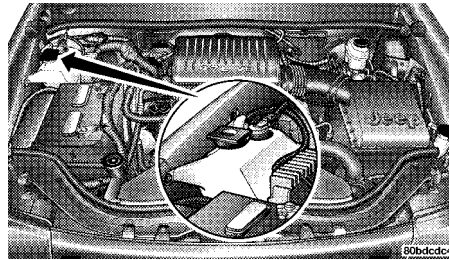

4.0/4.7L Engines

On vehicles equipped with a Vehicle Information Center, the low coolant level will be indicated. When the low coolant level is detected, the radiator will light on the vehicle outline and the "Coolant Level Low" message will be displayed.

See your authorized dealer if the coolant level drops quickly.

Checking Coolant Level — Diesel Engines

The coolant level check is performed on the coolant Degasser bottle. The coolant level should be at the COLD MIN mark on the bottle.

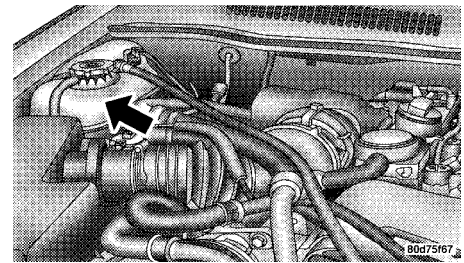

Points To Remember

NOTE:

When the vehicle is stopped after a few miles of operation, you may observe vapor coming from the front of the engine compartment. This is normally a result of moisture from rain, snow, or high humidity accumulating on the radiator and being vaporized when the thermostat opens, allowing hot coolant to enter the radiator.

If an examination of your engine compartment shows no evidence of radiator or hose leaks, the vehicle may be safely driven. The vapor will soon dissipate.

- Do not overfill the coolant bottle.
- Check coolant freeze point in the system.

- If frequent coolant additions are required, or if the level in the recovery bottle does not drop when the engine cools, the cooling system should be pressure tested for leaks.
- Maintain coolant concentration at 50% ethylene glycol antifreeze (minimum) in water for proper corrosion protection of your engine that contains aluminum components.
- Make sure that the radiator and coolant bottle hoses are not kinked or obstructed.
- Do not change the thermostat for summer or winter operation. If replacement is ever necessary, install ONLY the correct type thermostat. Other designs may result in unsatisfactory cooling performance, poor gas mileage, and increased emissions.

Hoses and Vacuum/Vapor Harnesses

Inspect surfaces of hoses and nylon tubing for evidence of heat and mechanical damage. Hard or soft spots, brittle rubber, cracking, tears, cuts, abrasions, and excessive swelling indicate deterioration of the rubber.

Pay particular attention to the hoses nearest to high heat sources such as the exhaust manifold. Inspect hose routing to be sure hoses do not touch any heat source or moving component that may cause heat damage or mechanical wear.

Insure nylon tubing in these areas has not melted or collapsed. Inspect all hose connections such as clamps and couplings to make sure they are secure and no leaks are present. Components should be replaced immediately if there is any evidence of degradation that could cause failure.

Brake System

In order to assure brake system performance, all brake system components should be inspected periodically. Refer to the appropriate "Maintenance Schedule" in Section 8 for suggested service intervals.

WARNING!

Riding the brakes can lead to brake failure and possibly an accident. Driving with your foot resting or riding on the brake pedal can result in abnormally high brake temperatures, excessive lining wear, and possible brake damage. You wouldn't have your full braking capacity in an emergency.

Brake and Power Steering System Hoses

When servicing the vehicle for scheduled maintenance, inspect surface of hoses for evidence of heat and mechanical damage. Hard and brittle rubber, cracking, tears, cuts, abrasion, and excessive swelling suggest deterioration of the rubber. Particular attention should be made to exam-

ining those hose surfaces nearest to high heat sources, such as the exhaust manifold.

Inspect all hose clamps and couplings to make sure they are secure and no leaks are present.

NOTE:

Often fluids such as oil, power steering fluid, and brake fluid are used during assembly plant operations to ease the assembly of hoses to couplings. Therefore, oil wetness at the hose-coupling area is not necessarily an indication of leakage. Actual dripping of hot fluid when systems are under pressure (during vehicle operation) should be noted before hose is replaced based on leakage.

NOTE:

Inspection of brake hoses should be done whenever the brake system is serviced and every engine oil change.

WARNING!

Worn brake hoses can burst and cause brake failure. You could have an accident. If you see any signs of cracking, scuffing, or worn spots, have the brake hoses replaced immediately.

Brake Master Cylinder

The fluid level in the master cylinder should be checked when performing under hood services, or immediately if the brake system warning lamp shows system failure

Be sure to clean the top of the master cylinder area before removing the cap. If necessary, add fluid to bring the fluid level up to the requirements described on the brake fluid reservoir. With disc brakes, fluid level can be expected to fall as the brake pads wear. However, low fluid level may be caused by a leak and a checkup may be needed.

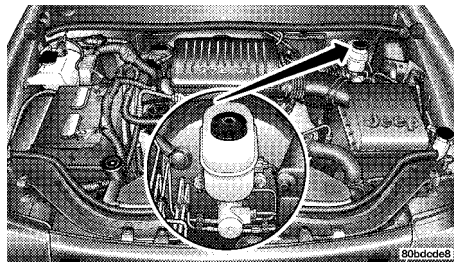

4.0/4.7L Engines

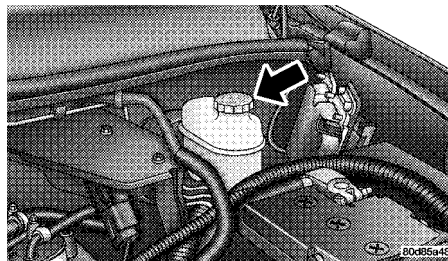

2.7L Diesel Engines

Use only manufacturer's recommended brake fluid, refer to Recommended Fluids, Lubricants, and Genuine Parts for correct fluid type.

WARNING!

Use a brake fluid that may have a lower initial boiling point or unidentified as to specification, may result in sudden brake failure during hard prolonged braking. You could have an accident.

Use only brake fluid that has been in a tightly closed container to avoid contamination from foreign matter. Do not allow petroleum base fluid to contaminate the brake fluid as seal damage will result.

Automatic Transmission

Fluid Type

It is important that the proper lubricant is used in the transmission to assure optimum transmission performance. Use only manufacturer's recommended transmission fluid, refer to Recommended Fluids, Lubricants, and Genuine Parts for correct fluid type. It is important that the transmission fluid be maintained at the prescribed level using the recommended fluid.

Fluid Level Check – 4.0L Engines

This fluid level should be checked when the engine is fully warmed up and the fluid in the transmission is heated to its normal operating temperature. Operation of the transmission with an improper fluid level will greatly reduce the life of the transmission and of the fluid. Check the fluid whenever the vehicle is serviced for other reasons.

NOTE:

Whenever the fluid level is checked, especially on a vehicle used in severe service, the condition of the fluid should be noted. If the fluid is dark and has a strong odor, fluid should be changed and the bands adjusted.

A physical change in the fluid may be the result of overheating, resulting in fluid degradation. This is possible in severe service or if the vehicle is equipped with a non-factory installed air-conditioning unit.

To check the automatic transmission fluid level properly, the following procedure must be used:

1. The vehicle must be on level ground.
2. The engine should be running at curb idle speed for a minimum of 60 seconds.
3. Fully apply parking brake.
4. Apply the service brakes and shift the transmission into D (Drive) and R (Reverse) for a minimum of two seconds in each gear position. Shift into N (Neutral).
5. The fluid **MUST** be checked with the transmission in N (Neutral).
6. Remove the dipstick and feel if the fluid is hot or warm. Hot fluid is approximately 180°F (82°C), the normal operating temperature after the vehicle has been driven at least 25 km (15 miles). The fluid cannot be comfortably held between the finger tips. Warm is when fluid is between 85° and 125°F (29° and 52°C).
7. Wipe the dipstick clean and reinsert until seated. Remove dipstick and note reading.
 - a. If the fluid is hot, the reading should be in the crosshatched area marked "OK".
 - b. If the fluid is warm, the reading should be above the "Min" hole and below the circle in the cross hatched area.

If the fluid level is low, add sufficient fluid to bring to the proper level. Refer to Recommended Fluids, Lubricants and Genuine Parts for correct fluid type.

Fluid is added through the dipstick tube.

NOTE:

To prevent dirt and water from entering the transmission after checking or replenishing fluid, make certain that the dipstick cap is properly resealed.

Fluid Level Check – 4.7L Engines

Check the fluid level while the transmission is at normal operating temperature 180°F (82°C). This occurs after at least 25 km (15 miles) of driving. At normal operating temperature the fluid cannot be held comfortably between the fingertips.

To check the automatic transmission fluid level properly, the following procedure must be used:

1. Operate the engine at idle speed and normal operating temperature.
2. The vehicle must be on level ground.
3. Fully apply the parking brake and press the brake pedal.
4. Place the gear selector momentarily in each gear position ending with the lever in P (Park).

5. Remove the dipstick, wipe it clean and reinsert it until seated.

6. Remove the dipstick again and note the fluid level on both sides. The fluid level should be between the "HOT" (upper) reference holes on the dipstick at normal operating temperature. Verify that solid coating of oil is seen on both sides of the dipstick. If the fluid is low, add as required into the dipstick tube. **Do not overfill.** After adding any quantity of oil through the oil fill tube, wait a minimum of two (2) minutes for the oil to fully drain into the transmission before rechecking the fluid level.

NOTE:

If it is necessary to check the transmission below the operating temperature, the fluid level should be between the two "COLD" (lower) holes on the dipstick with the fluid at approximately 21°C (70°F) (room temperature). If the fluid level is correctly established at room temperature, it should be between the "HOT" (upper) reference holes when the transmission reaches 82°C (180°F). Remember it is best to check the level at the normal operating temperature.

CAUTION!

Be aware that if the fluid temperature is below 10°C (50°F) it may not register on the dipstick. Do not add fluid until the temperature is elevated enough to produce an accurate reading.

7. Check for leaks. Release parking brake.

To prevent dirt and water from entering the transmission after checking or replenishing fluid, make certain that the dipstick cap is properly reseated. It is normal for the dipstick cap to spring back slightly from its fully seated position, as long as its seal remains engaged in the dipstick tube.

Fluid Level Check – 2.7L Diesel Engines

The fluid level is set at the factory. The dipstick tube is sealed and should not be tampered with. No transmission fluid level dipstick is provided. Your authorized dealer has the proper tools to ensure that the fluid level is set properly.

Automatic Transmission Fluid and Filter Change

To obtain best performance and long life for automatic transmissions, the manufacturer recommends that they be given regular maintenance service by an authorized dealer or service center. It is important that the transmission be adjusted

periodically, the fluid maintained at the correct level, and that it be drained and refilled as specified.

CAUTION!

Never overfill the automatic transmission. Foaming and loss of fluid through the vent or filler tube, and malfunction, may result.

Special Additives

The manufacturer recommends against the addition of any additives to the transmission. Exception to this policy is the use of special dyes to aid in detecting fluid leaks.

Transfer Case**Fluid Level Check**

Inspect the transfer case for fluid leaks. If a fluid leak is found, the transfer case fluid level can be checked by removing the filler plug located on the back side of the transfer case. The fluid level should be at the bottom edge of the filler plug hole when the vehicle is in a level position.

Adding Fluid

Add fluid at the filler hole until it runs out of the hole when the vehicle is in a level position.

Draining Fluid

First remove fill plug, then remove drain plug. Recommended tightening torque for drain and fill plugs is 20–34 N·m (15–25 ft. lbs.).

CAUTION!

When replacing plugs, do not overtighten. You could damage them and cause them to leak.

Selection of Lubricant

Use only manufacturer's recommended fluid, refer to Recommended Fluids, Lubricants, and Genuine Parts for correct fluid type.

Front/Rear Axle Fluid**Fluid Level Check**

Lubricant should be 13mm (1/2") below the oil fill hole.

Adding Fluid

Add lubricant only at the fill hole and only to the level specified above.

Selection of Lubricant

Use only manufacturer's recommended fluid, refer to Recommended Fluids, Lubricants, and Genuine Parts for correct fluid type.

Appearance Care And Protection From Corrosion

Protection of Body and Paint from Corrosion

Vehicle body care requirements vary according to geographic locations and usage. Chemicals that make roads passable in snow and ice, and those that are sprayed on trees and road surfaces during other seasons, are highly corrosive to the metal in your vehicle.

The following maintenance recommendations will enable you to obtain maximum benefit from the corrosion resistance built into your vehicle.

What Causes Corrosion?

Corrosion is the result of deterioration or removal of paint and protective coatings from your vehicle.

The most common causes are:

- Road salt, dirt and moisture accumulation.
- Stone and gravel impact.
- Insects, tree sap and tar.
- Salt in the air near seacoast localities.
- Atmospheric fallout/industrial pollutants.

Washing

- Wash your vehicle regularly. Always wash your vehicle in the shade using a mild car wash soap and rinse the panels completely with clear water.
- If insects, tar or other similar deposits have accumulated on your vehicle, wash it as soon as possible.
- Use Mopar® Auto Polish to remove road film and stains and to polish your vehicle. Take care never to scratch the paint.
- Avoid using abrasive compounds and power buffing that may diminish the gloss or thin out the paint finish.

CAUTION!

Do not use abrasive or strong cleaning materials such as steel wool or scouring powder, which will scratch metal and painted surfaces.

Special Care

- If you drive on salted or dusty roads or if you drive near the ocean, hose off the undercarriage at least once a month.
- The drain holes in the lower edges of the doors, rocker panels and rear liftgate must be kept clear and open.
- If you detect any stone chips or scratches in the paint, touch them up immediately. The cost of such repairs is considered the responsibility of the owner.
- If your vehicle is damaged due to an accident or similar cause which destroys the paint and protective coating, have your vehicle repaired as soon as possible. The cost of such repairs is considered the responsibility of the owner.
- If you carry special cargo such as chemicals, fertilizers, de-icer salt, etc., assure that such materials are well packaged and sealed.
- If a lot of driving is done on gravel roads, consider mud or stone shields behind each wheel.

- Use Mopar® Touch-Up Paint on scratches as soon as possible. Your authorized dealer has touch-up paint to match the color of your vehicle.
- Aluminum wheels should be cleaned regularly with mild soap and water to prevent corrosion. To remove heavy soil, select a nonabrasive, non-acidic cleaner. Do not use scouring pads or metal polishes. Avoid automatic car washes that use acidic solutions or harsh brushes that may damage the wheels' protective finish.

Interior Care

Use Mopar® Fabric Cleaner to clean fabric upholstery and carpeting.

Use Mopar® Vinyl Cleaner to clean vinyl upholstery.

Mopar® Vinyl Cleaner is specifically recommended for interior vinyl trim.

Do not use silicon based cleaning products on leather seats. They could cause cracking of the seat leather.

Leather Seat Care & Cleaning

Leather is best preserved by regular cleaning with a damp soft cloth. Small particles of dirt can act as an abrasive and damage the leather surface and should be removed promptly with a damp cloth. Stubborn soils can be removed easily with a soft cloth and Mopar® Total Clean. Care should be taken to avoid soaking the leather with any liquid. Please do not use polishes, oils, cleaning fluids, solvents, detergents, or ammonia based cleaners to clean the leather. Application of a leather conditioner is not required to maintain the original condition.

Glass Surfaces

All glass surfaces should be cleaned on a regular basis with any commercial household-type glass cleaner. Never use an abrasive type cleaner. Use caution when cleaning inside rear windows equipped with electric defrosters. Do not use scrapers or other sharp instruments which may scratch the elements.

When cleaning the rear view mirror, spray cleaner on the towel or rag that you are using. Do not spray cleaner directly on the mirror.

WARNING!

Do not use volatile solvents for cleaning purposes. Many are potentially flammable, and if used in closed areas they may cause respiratory harm. Do not use gasoline, turpentine, kerosene, etc. for cleaning. Use the Mopar® recommended products or the equivalents.

FUSE PANEL

Interior Fuses

The fuse panel is on the lower instrument panel just to the left of the steering column. A label is stamped on the fuse panel cover to identify each fuse for ease of replacement.

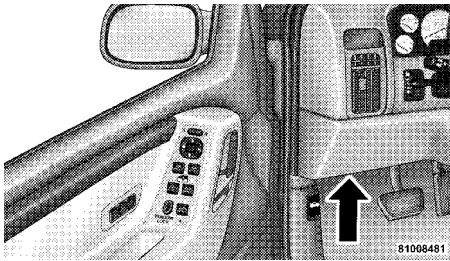

Cavity	Fuse	Description
1	Spare	
2	Spare	
3	10 Amp Red	Headlight High Beam Left
4	15 Amp Lt. Blue	Flasher
5	25 Amp Natural	Radio/Amplifier
6	15 Amp Lt. Blue	Park Lights

Cavity	Fuse	Description
7	10 Amp Red	Interior Lights
8	15 Amp Lt. Blue	Overhead Console, Rear Wiper, IP Lights, Rear Flipper Glass Solenoid
9	20 Amp Yellow	Power Outlets
10	20 Amp Yellow	Adjustable Pedals
11	10 Amp Red	Rear Window Defroster Indicator
12	10 Amp Red	Auto Shut Down Relay/ "Fuel"
13	Spare	
14	10 Amp Red	Headlight Low Left
15	10 Amp Red	Headlight Low Right
16	10 Amp Red	Headlight High Right
17	10 Amp Red	Instrument Cluster, Diag- nostic Connector
18	30 Amp	Trailer Tow
19	10 Amp Red	Antilock Brakes
20	10 Amp Red	Ignition Run
21	10 Amp Red	Ignition Run/Start - PDC

Cavity	Fuse	Description
22	10 Amp Red	Ignition Run/Start
23	15 Amp Lt. Blue	Brake Switch
24	15 Amp Lt. Blue	Fog Lamps
25	20 Amp Yellow	Accessory Delay Relay (Sunroof)
26	15 Amp Lt. Blue	Cigar
27	15 Amp Lt. Blue	Rear Fog Lamps (If Equipped)
28	10 Amp Red	Body Control Module, Acc/Run
29	10 Amp Red	Rear Wiper Switch, Washer Motors
30	15 Amp Lt. Blue	Radio
31	10 Amp Red	Ignition Start
32	10 Amp Red	Ignition Run/Start- Airbag
33	10 Amp Red	Ignition Run/Only - Air- bag
C1	20 Amp	Wiper (Circuit Breaker)
C2	20 Amp	Seats (Circuit Breaker)
C3		Spare

Underhood Fuses (Power Distribution Center)

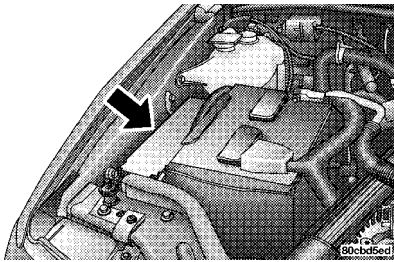

Your vehicle is equipped with an electrical power distribution center located in the engine compartment near the battery. This power center houses plug-in "Cartridge" fuses which replace in-line fusible links. The power center also contains "Mini" fuses and plug-in full and mini ISO relays. A label inside the latching cover of the center identifies each component for ease of replacement, if necessary. "Cartridge" fuses and relays can be obtained from your authorized dealer.

REPLACEMENT BULBS

Interior Lights	Bulb Type
A/C Heater	Not Serviceable
Ashtray Receiver Light	161
Climate Control (Dual Zone Automatic)	Not Serviceable
Climate Control (Manual A/C)	74
Front Reading	192
Glove Box Light	194
Overhead Console	192
Radio	ASC
Rear Cargo Light	214-2
Passenger Assist Handle Lights	214-2
Lighted Vanity Mirror *	P/N 6501966
Underpanel Courtesy Lights	906
Instrument Cluster (General Illumination)	103
Telltale/Hazard Light	74

* Available only from authorized dealers.

Exterior Lights	Bulb Type
Backup Lights	3157K
Center High-Mounted Stoplight	921
Fog Lights	9040
Front Park Lights (Limited)	194NA
Front Park Lights (Laredo)	194NA
Front Park/Turn Light (Limited)	3157A
Front Park/Turn Light (Laredo)	3157A
Front Side Marker (Limited)	194NA
Front Side Marker (Laredo)	194NA
Headlights (Low Beam)	9006XS
Headlights (High Beam)	9005XS
Rear License Plate Light	168
Rear Stop/Tail Lights	3157K
Rear Turn Signal Lights (2)	3157KA

NOTE:
Numbers refer to commercial bulb types that can be purchased from your authorized dealer.

If a bulb needs to be replaced, visit your authorized dealer or refer to the applicable Service Manual.

FLUID CAPACITIES

	Metric	U.S.
Fuel (Approximate)	76 Liters	20 Gallons
Engine Oil with Filter		
4.0, 4.7, & 4.7HO Liter Engine	5.7 Liters	6 Qts
2.7L Diesel Engine	6.5 Liters	7 Qts
Cooling System *		
4.0 Liter Engine	14 Liters	15 Qts
4.7 & 4.7HO Liter Engine	13.7 Liters	14.5 Qts
2.7L Diesel Engine	14 Liters	15 Qts

* Includes heater and coolant recovery bottle filled to MAX level.

RECOMMENDED FLUIDS, LUBRICANTS AND GENUINE PARTS

Engine

Component	Fluid, Lubricant, or Genuine Part
Engine Coolant	Mopar® Antifreeze/Coolant 5 Year/100,000 Mile Formula HOAT (Hybrid Organic Additive Technology)
Engine Oil (Gasoline Engines)	Use API Certified (GF-3). Refer to oil viscosity chart for correct SAE grade.
Engine Oil (Diesel Engines)	SAE 10W-40 is recommended for temperatures between 35°C (95°F) and –10°C (14°F). Oils of the SAE 5W-30 grade are preferred when the minimum temperature consistently falls below –10°C. If SAE 5W-30 grade is not available, then SAE 5W-40 grade is acceptable. Use only Diesel Engine Oils conforming to API (American Petroleum Institute) Quality CH-4 or ACEA class B4.
Oil Filter (Gasoline Engines)	Mopar® Oil Filter (P/N 05281090)
Oil Filter (Diesel Engines)	Mopar® Oil Filter (P/N 05086301AA)
Spark Plugs	Refer to the Vehicle Emission Control Information label in the engine compartment.
Fuel Selection (Gasoline Engines)	91 Octane

Chassis

Component	Fluid, Lubricant, or Genuine Part
Automatic Transmission (Gasoline Engines)	Mopar® ATF+4 Automatic Transmission Fluid
Automatic Transmission (Diesel Engines)	Shell® 3403 Automatic Transmission Fluid (P/N 52107891AA)
Transfer Case	Quadra-Trac Models - Mopar® Transfer Case Fluid (P/N 05016796)
Axle Differential (front-rear)	Mopar® Synthetic Gear Lubricant or equivalent of SAE 75W-140 (API-GL5) if equipped with a Vari-Lok® front axle. Mopar® Gear Lubricant or equivalent of SAE 80W-90 (API-GL5) if not equipped with a Vari-Lok® front axle. Mopar® Synthetic Gear Lubricant or equivalent of SAE 75W-140 (API-GL5) if equipped with a Dana M35 or M44 Vari-Lok® rear axle. Mopar® Gear Lubricant or equivalent of SAE 80W-90 (API-GL5) if equipped with a Dana M44 rear axle without Vari-Lok®. For trailer towing applications, use a SAE 75W-140 Synthetic Gear Lubricant in rear axle. Vari-Lok® equipped axles require a friction modifier additive.
Brake Master Cylinder	Mopar® Brake Fluid DOT 3 Motor Vehicle. If Mopar® brake fluid conforming to SAE J1703 standards is not available, then DOT 4 or DOT 4+ brake fluid is acceptable.
Power Steering Reservoir	Mopar® Power Steering Fluid
Ball Joints, Prop Shafts, U-Joints, Yokes, & Wheel Bearings	Mopar® Multi-Purpose Lube NLGI Grade 2 EP, GC-LB

Body

Component	Fluid, Lubricant, or Genuine Part
Hinges:	
Door & Hood	Mopar® Engine Oil
Liftgate	Mopar® Multi-Purpose Lube NLGI Grade 2 EP, GC-LB
Latches: Door, Hood/Safety Catch Liftgate	Mopar® Multi-Purpose Lube NLGI Grade 2 EP, GC-LB
Seat Regulator & Track	Mopar® Multi-Purpose Lube NLGI Grade 2 EP, GC-LB
Window System Components	Mopar® Spray White Lube
Lock Cylinders	Mopar® Lock Cylinder Lube

MAINTENANCE SCHEDULES

• MAINTENANCE SCHEDULES	118
• Schedule "B"	119
• Schedule "A"	126
• MAINTENANCE SCHEDULE — DIESEL ENGINES	129
• Schedule "B"	130
• Schedule "A"	133

MAINTENANCE SCHEDULES

There are two maintenance schedules that show the **required** service for your vehicle.

First is Schedule **"B"**. It is for vehicles that are operated under the conditions that are listed below and at the beginning of the schedule.

- Day or night temperatures are below 0°C (32°F)
- Stop and go driving
- Extensive engine idling
- Driving in dusty conditions
- Short trips of less than 16.2 km (10 miles)
- More than 50% of your driving is at sustained high speeds during hot weather, above 32°C (90°F)
- Trailer towing
- Taxi, police, or delivery service (commercial service)
- Off-road or desert driving
- **If equipped for and operated with E-85 (ethanol) fuel.**

NOTE:

Most vehicles are operated under the conditions listed for Schedule "B."

Second is Schedule **"A"**. It is for vehicles that are not operated under any of the conditions listed under Schedule "B."

Use the schedule that best describes your driving conditions. Where time and mileage are listed, follow the interval that occurs first.

CAUTION!

Failure to perform the required maintenance items may result in damage to the vehicle.

At Each Stop for Fuel

- Check the engine oil level about 5 minutes after a fully warmed engine is shut off. Checking the oil level while the vehicle is on level ground will improve the accuracy of the oil level reading. Add oil only when the level is at or below the ADD or MIN mark.
- Check the windshield washer solvent and add if required.

Once a Month

- Check the tire pressure and look for unusual wear or damage.
- Inspect the battery and clean and tighten the terminals as required.
- Check the fluid levels of coolant reservoir, brake master cylinder, power steering, and transmission and add as needed.
- Check all lights and all other electrical items for correct operation.

At Each Oil Change

- Change the engine oil filter.
- Inspect the exhaust system.
- Inspect brake hoses.
- Check the coolant level, hoses, and clamps.
- Rotate the tires.
- After completion of off-road operation, the underside of the vehicle should be thoroughly inspected. Examine threaded fasteners for looseness.

Schedule “B”

Follow schedule “B” if you usually operate your vehicle under one or more of the following conditions.

- Day or night temperatures are below 0°C (32°F)
- Stop and go driving

- Extensive engine idling
- Driving in dusty conditions
- Short trips of less than 16.2 km (10 miles)
- More than 50% of your driving is at sustained high speeds during hot weather, above 32°C (90°F)

- Trailer towing
- Taxi, police, or delivery service (commercial service)
- Off-road or desert driving
- **If equipped for and operated with E-85 (ethanol) fuel.**

Kilometers (Miles)	5 000 (3,000)	10 000 (6,000)	14 000 (9,000)	19 000 (12,000)	24 000 (15,000)
Change the engine oil and engine oil filter.	X	X	X	X	X
Lubricate the upper knuckle ball stud at steering & suspension ball joints.		X		X	
Drain and refill the front and rear axles.				X	
Inspect the engine air cleaner filter, replace if necessary.					X
Inspect the brake linings.				X	
Clean and lubricate the brake caliper pins.				X	

Kilometers (Miles)	29 000 (18,000)	34 000 (21,000)	38 000 (24,000)	43 000 (27,000)	48 000 (30,000)
Change the engine oil and engine oil filter.	X	X	X	X	X
Lubricate the upper knuckle ball stud at steering & suspension ball joints.	X		X		X
Drain and refill the front and rear axles.			X		
Inspect the brake linings.			X		
Clean and lubricate the brake caliper pins.			X		
Replace the engine air cleaner filter, replace if necessary.					X
Inspect the PCV valve, replace if necessary (4.7L Only). ◇					X
Replace the spark plugs.					X
Drain and refill the automatic transmission fluid, change filter, and adjust bands (4.0L Only).					X
Drain and refill the automatic transmission fluid, and replace main sump filter (4.7L Only).					X
Drain the transfer case and refill (Quadra-Trac Models Only).					X

Kilometers (Miles)	53 000 (33,000)	58 000 (36,000)	62 000 (39,000)	67 000 (42,000)	72 000 (45,000)
Change the engine oil and engine oil filter.	X	X	X	X	X
Drain and refill the front and rear axles.		X			
Inspect the brake linings.		X			
Inspect the engine air cleaner filter, replace if necessary.					X
Lubricate the upper knuckle ball stud at steering & suspension ball joints.		X		X	
Clean and lubricate the brake caliper pins.		X			
Inspect and replace drive belt if necessary (4.0L Only).					X

Kilometers (Miles)	77 000 (48,000)	82 000 (51,000)	86 000 (54,000)	91 000 (57,000)	96 000 (60,000)
Change the engine oil and engine oil filter.	X	X	X	X	X
Lubricate the upper knuckle ball stud at steering & suspension ball joints.	X		X		X
Clean and lubricate brake caliper pins.	X				X
Inspect the engine air filter element, replace if necessary.					X
Inspect the PCV valve, replace if necessary (4.7L Only). ◇					X
Replace the spark plugs.					X
Inspect the brake linings.	X				X
Drain and refill the front and rear axles.	X				X
Drain and refill the automatic transmission fluid, change filter, and adjust bands (4.0L Only).					X
Drain and refill the automatic transmission fluid, and replace main sump filter (4.7L Only).					X
Drain and replace brake fluid.					X
Inspect the drive belt and replace as needed. Not required if belt was previously replaced (4.0L Only).					X
Drain and refill the transfer case fluid (Quadra-Trac Models).					X

Kilometers (Miles)	101 000 (63,000)	106 000 (66,000)	110 000 (69,000)	115 000 (72,000)	120 000 (75,000)
Change the engine oil and engine oil filter.	X	X	X	X	X
Lubricate the upper knuckle ball stud at steering & suspension ball joints.		X		X	
Inspect the engine air filter element, replace if necessary.					X
Inspect the brake linings.				X	
Clean and lubricate the brake caliper pins.				X	
Drain and refill the front and rear axle fluid†				X	
Inspect the drive belt and replace as needed. Not required if belt was previously replaced (4.0L Only).					X
Inspect the drive belt and replace as needed (4.7L Only).					X

Kilometers (Miles)	125 000 (78,000)	130 000 (81,000)	134 000 (84,000)	139 000 (87,000)	144 000 (90,000)
Change the engine oil and engine oil filter.	X	X	X	X	X
Lubricate the upper knuckle ball stud at steering and suspension ball joints.	X		X		X
Inspect the engine air filter element, replace if necessary.					X
Replace the spark plugs.					X
Inspect the PCV valve, replace if necessary (4.7L Only). ◇					X
Drain and refill the transfer case fluid (Quadra-Trac Only).					X
Inspect the brake linings.			X		
Clean and lubricate the brake caliper pins.			X		
Drain and refill the front and rear axle fluid‡			X		
Drain and refill the automatic transmission fluid, change filter, and adjust bands (4.0L Only).					X
Drain and refill the automatic transmission fluid, replace main sump filter, and spin-on cooler return filter (if equipped) (4.7L Only).					X
Inspect the drive belt and replace as needed. Not required if belt was previously replaced (4.0L and 4.7L).					X

Kilometers (Miles)	149 000 (93,000)	154 000 (96,000)	160 000 (100,000)	163 000 (102,000)	168 000 (105,000)
Change the engine oil and engine oil filter.	X	X	X	X	X
Lubricate the upper knuckle ball stud at steering & suspension ball joints.		X		X	
Inspect the engine air filter element, replace if necessary.					X
Inspect the brake linings.		X			
Clean and lubricate the brake caliper pins.		X			
Drain and refill the front and rear axle fluid‡		X			
Inspect the drive belt and replace as needed. Not required if belt was previously replaced (4.0L and 4.7L).					X
Flush and replace the engine coolant.			X		

Kilometers (Miles)	173 000 (108,000)	178 000 (111,000)	182 000 (114,000)	187 000 (117,000)	192 000 (120,000)
Change the engine oil and engine oil filter.	X	X	X	X	X
Lubricate the upper knuckle ball stud at steering & suspension ball joints.	X		X		X
Inspect the engine air filter element, replace if necessary.					X
Replace the spark plugs.					X
Inspect the PCV valve, replace if necessary (4.7L Only). ◇					X
Inspect the brake linings.	X				X
Clean and lubricate the brake caliper pins.	X				X
Drain and replace the brake fluid.					X
Drain and refill the front and rear axle fluid ‡	X				X
Drain and refill the automatic transmission fluid, change filter, and adjust bands (4.0L Only).					X
Drain and refill the automatic transmission fluid, and replace main sump filter (4.7L Only).					X
Inspect the drive belt and replace as needed. Not required if belt was previously replaced (4.0L and 4.7L).					X
Drain and refill the transfer case fluid (Quadra-Trac Only).					X

◇ This maintenance is recommended by the manufacturer to the owner, but is not required to maintain emissions warranty.

‡Off-highway operation, trailer towing, taxi, limousine, bus, snow plowing, or other types of commercial service or prolonged operation with heavy loading, especially in hot weather, require front and rear axle service indicated with a ‡ in Schedule "B". Perform these services if the vehicle is usually operated under these conditions.

Schedule “A”

Kilometers (Miles) [Months]	12 000 (7,500) [6]	24 000 (15,000) [12]	36 000 (22,500) [18]	48 000 (30,000) [24]	60 000 (37,500) [30]
Change the engine oil and filter.	X	X	X	X	X
Lubricate the upper knuckle ball stud at steering & suspension ball-joints.		X		X	
Inspect the brake linings.			X		
Clean and lubricate the brake caliper pins.			X		
Replace the engine air cleaner filter.				X	
Replace the spark plugs.				X	
Drain the transfer case and refill (Quadra-Trac Only).				X	

Kilometers (Miles) [Months]	72 000 (45,000) [36]	84 000 (52,500) [42]	96 000 (60,000) [48]	108 000 (67,500) [54]
Change the engine oil and engine oil filter.	X	X	X	X
Inspect the brake linings.	X			X
Lubricate the upper knuckle ball stud at steering & suspension ball joints.	X		X	
Clean and lubricate the brake caliper pins.	X			X
Replace the engine air cleaner filter.			X	
Inspect the PCV valve, replace if necessary (4.7L Only) ◇.			X	
Replace the spark plugs.			X	
Inspect the Auto Tension Drive Belt, and replace if needed (4.0L Only).			X	
Drain and replace the brake fluid.			X	
Drain the transfer case, and refill (Quadra-Trac Only).			X	

Kilometers (Miles) [Months]	120 000 (75,000) [60]	132 000 (82,500) [66]	144 000 (90,000) [72]	156 000 (97,500) [78]
Change the engine oil and engine oil filter.	X	X	X	X
Lubricate the upper knuckle ball stud at steering & suspension ball joints.	X		X	
Inspect and replace the drive belt if necessary (4.0L Only). Not required if belt was previously replaced.	X		X	
Inspect and replace the drive belt if necessary (4.7L Only).			X	
Flush and replace the engine coolant.	X			
Replace the engine air cleaner filter.			X	
Replace the spark plugs.	X		X	
Inspect the PCV valve, replace if necessary (4.7L Only). ◇	X		X	
Drain and replace the brake fluid.	X			
Inspect the brake linings.			X	
Clean and lubricate the brake caliper pins.			X	
Drain the transfer case and refill (Quadra-Trac Only).			X	

Kilometers (Miles) [Months]	160 000 (100,000)	168 000 (105,000) [84]	180 000 (112,500) [90]	192 000 (120, 000) [96]
Change the engine oil and engine oil filter.		X	X	X
Drain and refill the automatic transmission fluid, change filter, and adjust bands (4.0L Only).	X			
Drain and refill the automatic transmission fluid, replace main sump filter, and spin-on cooler return filter (if so equipped) (4.7L Only).	X			
Flush and replace the engine coolant if not replaced at 60 months.	X			X
Inspect and replace the drive belt if not previously replaced (4.0L and 4.7L).		X		X
Lubricate the upper knuckle ball stud at steering & suspension ball joints.		X		X
Inspect brake linings.			X	
Clean and lubricate the brake caliper pins.			X	
Drain and replace brake fluid.				X
Replace the engine air cleaner filter.				X
Replace the spark plugs.				X
Inspect the PCV valve, replace if necessary (4.7L Only). ◇				X
Drain the transfer case and refill (Quadra-Trac Only).				X

Inspection and service should be performed any-time a malfunction is observed or suspected. Retain all receipts.

◇ This maintenance is recommended by the manufacturer to the owner, but is not required to maintain emissions warranty.

WARNING!

You can be badly injured working on or around a motor vehicle. Do only that service work for which you have the knowledge and the right equipment. If you have any doubt about your ability to perform a service job, take your vehicle to a competent mechanic.

MAINTENANCE SCHEDULE — DIESEL ENGINES

There are two maintenance schedules that show the **required** service for your vehicle.

First is Schedule **"B"**. It is for vehicles that are operated under the conditions listed at the beginning of the schedule.

- Extensive engine idling.
- Driving in dusty conditions.
- More than 50% of your driving is at sustained high speeds during hot weather, above 32° C (90° F).
- Trailer towing.
- Taxi, police, or delivery service (commercial service).
- Off-road or desert driving.

NOTE:

Most vehicles are operated under the conditions listed for Schedule "B."

Second is Schedule **"A"**. It is for vehicles that are not operated under any of the conditions listed under Schedule "B."

Use the schedule that best describes your driving conditions. Where time and mileage are listed, follow the interval that occurs first.

CAUTION!

Failure to perform the required maintenance items may result in damage to the vehicle.

At Each Stop for Fuel

- Check the engine oil level about 5 minutes after a fully warmed engine is shut off. Checking the oil level while the vehicle is on level ground will improve the accuracy of the oil level reading. Add oil only when the level is at or below the ADD or MIN mark.
- Check the windshield washer solvent, and add as required.

Once a Month

- Check the tire pressure and look for unusual wear or damage.
- Inspect the battery, clean and tighten the terminals as required.
- Check the fluid levels of the coolant reservoir, brake master cylinder, power steering, and transmission, and add as needed.
- Check all lights and all other electrical items for correct operation.

At Each Oil Change

- Change the engine oil filter.
- Inspect the exhaust system.
- Inspect the brake hoses.
- Inspect front suspension ball joints.
- Check the coolant level, hoses, and clamps.
- Inspect engine accessory drive belts, replace as necessary.
- Inspect for the presence of water in the fuel filter/water separator unit.
- Rotate the tires.
- After completion of off-road operation, the underside of the vehicle should be thoroughly inspected. Examine threaded fasteners for looseness.

Schedule “B”

Follow schedule “B” if you usually operate your vehicle under one or more of the following conditions.

- Extensive engine idling.

- Driving in dusty conditions.
- More than 50% of your driving is at sustained high speeds during hot weather, above 32° C (90° F).

- Trailer towing.
- Taxi, police, or delivery service (commercial service).

Kilometers	10 000 km	20 000 km	30 000 km	40 000 km	50 000 km
Change the engine oil and engine oil filter.	X	X	X	X	X
Lubricate the upper knuckle ball stud at steering & suspension ball joints.	X	X	X	X	X
Drain and refill the front and rear axles.		X		X	
Inspect the engine air filter element. Replace as necessary.	X		X		X
Replace the engine air filter element.		X		X	
Replace the fuel filter/water separator unit.		X		X	
Inspect the brake linings.		X		X	
Clean and lubricate the brake caliper pins.		X		X	
Drain the transfer case and refill (Quadra-Trac Only).					X

Kilometers	60 000 km	70 000 km	80 000 km	90 000 km	100 000 km
Change the engine oil and engine oil filter.	X	X	X	X	X
Lubricate the upper knuckle ball stud at steering & suspension ball joints.	X	X	X	X	X
Drain and refill the front and rear axles.	X		X		X
Inspect the brake linings.	X		X		X
Clean and lubricate the brake caliper pins.	X		X		X
Drain and replace brake fluid.					X
Inspect the engine air filter element. Replace as necessary.		X		X	
Replace the engine air filter element.	X		X		X
Replace the fuel filter/water separator unit.	X		X		X
Inspect the accessory drive belt and replace if needed.					X
Drain and refill the automatic transmission fluid, and change filter.					X
Drain and refill the transfer case fluid (Quadra-Trac Only).					X

Kilometers	110000 km	120 000 km	130000 km	140000 km	150000 km	160000 km
Change the engine oil and engine oil filter.	X	X	X	X	X	X
Lubricate the upper knuckle ball stud at steering & suspension ball joints.	X	X	X	X	X	X
Inspect the brake linings.		X		X		X
Clean and lubricate the brake caliper pins.		X		X		X
Drain and refill the front and rear axle fluid.		X		X		X
Inspect the engine air filter element. Replace as necessary.	X		X		X	
Replace the engine air filter element.		X		X		X
Replace the fuel filter/water separator unit.		X		X		X
Flush and replace the engine coolant.						X
Drain and refill the transfer case (Quadra-Trac Only).				X		

Inspection and service should also be performed anytime a malfunction is observed or suspected. Retain all receipts.

Schedule “A”

Kilometers	20 000 km	40 000 km	60 000 km	80 000 km	100 000 km
Change the engine oil and engine oil filter.	X	X	X	X	X
Lubricate the upper knuckle ball stud at the steering & suspension ball joints.	X	X	X	X	X
Inspect the brake linings.		X		X	
Clean and lubricate the brake caliper pins.		X		X	
Drain and replace the brake fluid.				X	
Inspect the engine air filter element. Replace as necessary.	X		X		X
Replace the engine air filter element.		X		X	
Replace the fuel filter/water separator unit.		X		X	
Inspect the accessory drive belt, and replace if necessary.					X
Drain the transfer case and refill (Quadra-Trac Only).		X		X	

Kilometers	120 000 km	140 000 km	160 000 km	180 000 km
Change the engine oil and engine oil filter.	X	X	X	X
Lubricate the upper knuckle ball stud at the steering & suspension ball joints.	X	X	X	X
Inspect the brake linings.	X		X	
Clean and lubricate the brake caliper pins.	X		X	
Drain and replace the brake fluid.			X	
Inspect the engine air filter element. Replace as necessary.		X		X
Replace the engine air filter element	X		X	
Replace the fuel filter/water separator unit.	X		X	
Flush and replace the engine coolant.			X	
Inspect the accessory drive belt, and replace if necessary.				X
Drain the transfer case and refill (Quadra-Trac Only).		X		
Drain the transfer case and refill (Quadra-Trac Only).				X

Inspection and service should also be performed anytime a malfunction is observed or suspected. Retain all receipts.

WARNING!

You can be badly injured working on or around a motor vehicle. Do only that service work for which you have the knowledge and the right equipment. If you have any doubt about your ability to perform a service job, take your vehicle to a competent mechanic.

1st Service

Mileage _____

Repair Order No. _____

Date _____

STAMP AND SIGNATURE OF AUTHORIZED DEALER

2nd Service

Mileage _____

Repair Order No. _____

Date _____

STAMP AND SIGNATURE OF AUTHORIZED DEALER

3rd Service

Mileage _____

Repair Order No. _____

Date _____

STAMP AND SIGNATURE OF AUTHORIZED DEALER

4th Service

Mileage _____

Repair Order No. _____

Date _____

STAMP AND SIGNATURE OF AUTHORIZED DEALER

5th Service

Mileage _____

Repair Order No. _____

Date _____

STAMP AND SIGNATURE OF AUTHORIZED DEALER

6th Service

Mileage _____

Repair Order No. _____

Date _____

STAMP AND SIGNATURE OF AUTHORIZED DEALER

7th Service

Mileage _____

Repair Order No. _____

Date _____

STAMP AND SIGNATURE OF AUTHORIZED DEALER

8th Service

Mileage _____

Repair Order No. _____

Date _____

STAMP AND SIGNATURE OF AUTHORIZED DEALER

9th Service

Mileage _____

Repair Order No. _____

Date _____

STAMP AND SIGNATURE OF AUTHORIZED DEALER

10th Service

Mileage _____

Repair Order No. _____

Date _____

STAMP AND SIGNATURE OF AUTHORIZED DEALER

11th Service

Mileage _____

Repair Order No. _____

Date _____

STAMP AND SIGNATURE OF AUTHORIZED DEALER

12th Service

Mileage _____

Repair Order No. _____

Date _____

STAMP AND SIGNATURE OF AUTHORIZED DEALER

13th Service

Mileage _____

Repair Order No. _____

Date _____

STAMP AND SIGNATURE OF AUTHORIZED DEALER

14th Service

Mileage _____

Repair Order No. _____

Date _____

STAMP AND SIGNATURE OF AUTHORIZED DEALER

15th Service

Mileage _____

Repair Order No. _____

Date _____

STAMP AND SIGNATURE OF AUTHORIZED DEALER

16th Service

Mileage _____

Repair Order No. _____

Date _____

STAMP AND SIGNATURE OF AUTHORIZED DEALER

IF YOU NEED CONSUMER ASSISTANCE

• IF YOU NEED ASSISTANCE	142
• ARGENTINA	142
• AUSTRALIA	142
• AUSTRIA	142
• BALANCE OF THE CARIBBEAN	142
• BELGIUM	142
• BOLIVIA	142
• BRAZIL	142
• BULGARIA	143
• CHILE	143
• COLOMBIA	143
• COSTA RICA	143
• CROATIA	143
• CZECH REPUBLIC	143
• DENMARK	143
• DOMINICAN REPUBLIC	143
• ECUADOR	143
• EL SALVADOR	143
• ESTONIA	143

- FINLAND 144
- FRANCE 144
- GERMANY 144
- GRAND DUCHY OF LUXEMBOURG 144
- GREECE 144
- GUATEMALA (Note for Jeep Only) 144
- GUATEMALA (Note for Chrysler & Dodge) 144
- HONDURAS 144
- HUNGARY 144
- IRELAND 144
- ITALY 145
- LATVIA 145
- LITHUANIA 145
- NETHERLANDS 145
- NORWAY 145
- PANAMA 145
- PARAGUAY 145
- PERU 145
- POLAND 145
- PORTUGAL 145
- PUERTO RICO AND US VIRGIN ISLANDS 145
- ROMANIA 145
- RUSSIA 146
- SLOVENIA 146
- SPAIN 146

• SWEDEN	146
• SWITZERLAND	146
• TAIWAN	146
• UNITED KINGDOM	146
• URUGUAY	146
• VENEZUELA	146

IF YOU NEED ASSISTANCE

The manufacturer distributors are vitally interested in your satisfaction with their products and services. If a servicing problem or other difficulty should occur, we recommend that you take the following steps:

Discuss the problem at the authorized dealer with the dealer principal or the service manager. Management personnel at the authorized dealer are in the best position to resolve the problem quickly.

When you contact the distributor please provide all of the following information:

- Your name, address and phone number.
- Vehicle Identification Number (this 17 digit number is found on an etched plate or label, located on the left front corner of the instrument panel, visible through the windshield.. It is also available from your vehicle registration or title).
- Selling and servicing authorized dealer.
- Vehicle's delivery date and current odometer distance.
- Service history of your vehicle.
- An accurate description of the problem and the conditions under which it occurs.

ARGENTINA

DaimlerChrysler Argentina S.A.
Av. del Libertador 2424, Piso 11
C1425AAX-Bs. As.
Buenos Aires, Argentina
Tel.: (+ 54-11) 4808-8700

AUSTRALIA

DaimlerChrysler
Australia/Pacific Pty. Ltd.
ACN 004 411 410
Chrysler Vehicle Division
P.O. Box 4214 Mulgrave 3170
Ph. (03) 8561-5000

AUSTRIA

TNT MAILFAST
C/O Chrysler Austria
BRU/BRU/37850
P.O. BOX 195
IZ NOE SUED OBJ 58B
STRASSE 7
A-2355 WIENER NEUDORF
Tel.: 01 546 5151 31
Fax: 01 546 5151 32

BALANCE OF THE CARIBBEAN

Interamericana Trading Company
Warrens, St. Michael
Barbados, West Indies
Tel.: 246-417-8000
Fax: 246-425-2888

BELGIUM

TNT MAILFAST
C/O Chrysler Austria
BRU/BRU/37850
Antwoord Nummer 1930-32
B-1930 Zaventem
Tel.: 0800/94634
Fax: 02 717 33 01

BOLIVIA

Corporacion Transandina S.R.L.
Plaza Isabel La Catolica 2479
P.O. Box 12316
Tel.: (591-2) 243-0043
Fax: (591-2) 244-2887

BRAZIL

DaimlerChrysler do Brasil Ltda.
Av. Alfred Jursykowski, 562
09701-970 Sao Bernardo do Campo-S.P.
Tel.: 55-0-800-90-90-90
Fax: 55-19-3725-3635

BULGARIA

BALKAN STAR
Resbarska Str. 5
1510 Sofia
Tel.: 359 2 91988
Fax: 359 2 945 40 14

CHILE

Comercial Chrysler S.A.
Av. Americo Vespucio 1601, Quilicura
Santiago
Tel.: 56-2-620-7650
Fax: 56-2-603-1902

COLOMBIA

Crump America S.A.
Autopista Norte Km. 19
Santafé de Bogotá
Tel.: 571-667-1000
Fax: 571-676-0174

COSTA RICA

Auto Matra
La Uruca Antiguo Edificio Matra, Apt. 124
San Jose
Tel.: 506-295-0366
Fax: 506-221-7741

CROATIA

EUROLINE d.o.o.
Kovinska 5
10 000 Zagreb
Tel.: 385 1 3441 111
Fax: 385 1 3441 113

CZECH REPUBLIC

DaimlerChrysler Automotive Bohemia s.r.o.
corner – Türkova and mirového hnutí
149 00 Prague 4 – Chodov
Czech Republic
Tel.: 420-2-71077-111
Tel.: 420-2-25101-111
Fax: 420-2-71077-507

DENMARK

CHRYSLER JEEP DENMARK
C/O TNT
BRU/BRU/37850
POSTBOKS 1513
2650 HVIDOVRE
Tel.: 35 256 830
Fax: 35 256 832

DOMINICAN REPUBLIC

Reid Y Pellerano C. Por A.
John F. Kennedy Casi Esq. Lope de Vega
Santo Domingo
Tel.: 809-562-7211
Fax: 809-562-3667

ECUADOR

Chrysler Jeep Automotriz del Ecuador
Av. Juan Tanca Marengo y Calle 11
Guayaquil
Tel.: 59-3-429-2244
Fax: 59-3-428-7835

EL SALVADOR

Intermotores S.A.
Colonia y Boulevard Santa Elena y Calle Apa-
nencia
Antiguo Cuscatlan, San Salvador
Tel.: 503-273-0988
Fax: 503-289-3055

ESTONIA

Silberauto AS
Järvevana tee 11
11314 Tallinn
Tel.: 06 266 098
Tel.: 06 266 050
Fax: 06 266 066

FINLAND

Aro Yhtymä Oy — Chrysler Division
Ristipellontie 1-9
00390 Helsinki
Tel.: 09 547 7393
Tel.: 09 547 7531
Fax: 09 547 7485
Fax: 09 547 7378

FRANCE

TNT MAILFAST
C/O Chrysler France
BRU/BRU/37850
Boite Postale 52
93152 Le Blanc Mesnil Cedex
Tel.: 01 64 53 80 01
Fax: 01 64 53 80 02

GERMANY

TNT MAILFAST GmbH
C/O Chrysler Deutschland
BRU/BRU/37850
Postfach 920109
51151 Köln
Tel.: 01803 000361
Fax: 01803 000363

GRAND DUCHY OF LUXEMBOURG

TNT MAILFAST
C/O DaimlerChrysler Belgium/Luxembourg
BRU/BRU/37850
Antwoord Nummer 1930-32
1930 Zaventem
Belgium
Tel.: 0800 6661
Fax: 32 02 717 33 01

GREECE

Chrysler Jeep Import Hellas S.A.
131, Iera Odos Str.
122 41 Athens
Tel.: 01 3428412
Fax: 01 3428418

GUATEMALA (Note for Jeep Only)

Importadora Comercial Industrial S.A. (ICISA)
24 Calle 5-78, Zona 11
Apartado 2296
Ciudad de Guatemala
Tel.: 502-276-0841
Fax: 502-276-5786

GUATEMALA (Note for Chrysler & Dodge)

Vimeco
7A AV. 14-80 Zona 9
Ciudad de Guatemala
Tel.: 502-231-0084
Fax: 502-232-6119

HONDURAS

Carros Americanos SACV
Boulevard Centro América
Tegucigalpa
Tel.: 504-359268
Fax: 504-321795

HUNGARY

Chrysler Jeep Import Hungary
Mogyoródi út 34-40
Budapest, H-1149
Tel.: 01 2672116
Tel.: 01 2672117
Fax: 01 2672115

IRELAND

C.J. IRELAND CONCESSIONAIRES LIMITED
P.O. Box 4877
Walkinstown Avenue
Dublin 12
Tel.: 01 456 5445
Fax: 01 456 5446

ITALY

TNT MAILFAST
C/O Chrysler Italy
BRU/BRU/37850
CASSELLA POSTALE 29
20092 CINISELLO BALSAMO
Tel.: 06/41 442812
Fax: 06/41 442097

LATVIA

TC MOTORS LTD.
40 Krasta Str.
LV-1003 Riga
Tel.: 07 812 312
FAX: 07 812 313

LITHUANIA

UAB "Chrysler Jeep Autocentras"
Laisves av. 125 A
LT — 2022 VILNIUS
Tel.: 02 301037
Fax: 02 301036

NETHERLANDS

DaimlerChrysler Nederland
Postbus 216
4130 EE Vianen
Tel: 0347 36 34 00
Fax: 0347 37 75 25

NORWAY

Møller U.S. Import A/S
Økernveien 99
0513 Oslo
Tel.: 47 22 88 29 00
Fax: 47 22 88 29 05

PANAMA

Motores Superiores S.A.
Apartado 87-2079
Calle 50 y Av. No. 68
Panamá 7
Tel.: 507-270-1144
Fax: 507-270-1976

PARAGUAY

Cencar S.A.
Av. Mcal Lopez Esq. Tte. Jose Lopez
Asuncion, Paraguay
Tel.: 595-21-515-911
Fax: 595-21-515-924

PERU

Divemotor S.A.
Av. Canada 1160 La Victoria
Lima, Peru
Tel.: 51-1-224-0522
Fax: 51-1-224-0266

POLAND

DaimlerChrysler Automotive Polska
Chrysler Office
Stawki 2 (36 Pietro)
00-193 Warszawa
Tel.: 022 860 68 00
Fax: 022 860 68 05

PORTUGAL

Chrysler Jeep Import Portugal
Avenida da Liberdade 110-3º
1269-046 Lisboa
Tel.: 21 323 91 00
Fax: 21 323 91 99

PUERTO RICO AND U.S. VIRGIN ISLANDS

Chrysler International Services, S.A.
P.O. Box 191857
San Juan 00919-1857
Tel.: 787-782-5757
Fax: 787-782-3345

ROMANIA

S.C. Auto Rom S.R.L.
Bucuresti
Bd. Expozitiei nr. 2
RO-78334
Tel.: 01 2240020 25
Fax: 01 2241638

RUSSIA

DaimlerChrysler Automotive Russia SAO
1st Kolobovskij pereulok 23
103051 Moscow
Tel.: 095 926 40 40
Fax: 095 926 40 36

SLOVENIA

Chrysler/Jeep Import d.d.
Leskoskova 2
1122 Ljubljana
Tel.: 01 5843 138
Fax: 01 5843 222

SPAIN

S.E. Chrysler Iberia S.A.
Carretera N-1, Km. 32100
San Agustin de Guadalix
28750 Madrid
Tel.: 091 843 50 82
Fax: 091 843 51 88

SWEDEN

Chrysler Jeep Sverige
P.O. Box 93
BRU/BRU/37850
191 22 Sollentuna
Tel.: 08 752 9858
Fax: 08 752 6483

SWITZERLAND

DaimlerChrysler Schweiz AG-Vertrieb
Chrysler und Jeep
C/O TNT International Mail
BRU/BRU/37850
Aerogare Fret
CP 1144
CH 1215 Geneve 15
Tel.: 0800 802920 (German)
Tel.: 0800 802921 (French)
Tel.: 0800 802922 (Italian)
Fax: 01 210 41 44

TAIWAN

Chrysler Taiwan Co., LTD.
13th Floor Union Enterprise Plaza
109 Min Sheng East Road, Section 3
Taipei Taiwan R.O.C.
Tel.: 080-081-581
Fax: 8862-2547-1871

UNITED KINGDOM

DaimlerChrysler UK Ltd.
Tongwell
Milton Keynes MK15 8BA
Tel.: 01908 301090
Fax: 01908 301203

URUGUAY

Ambrois
25 de Agosto 709
Montevideo, Uruguay
Tel: 59-82-902-3993
Fax: 59-82-902-1651

VENEZUELA

DaimlerChrysler de Venezuela LLC.
Centro Corimon Valencia, Carretera Nacional
Flor Amarillo, Edif. Bucare-Valencia, Edo. Carabobo
Tel.: (58) 0241-8744725
Fax: (58) 0241-8744757
Fax: (58) 0241-8744739

CHANGE OF OWNERSHIP NOTIFICATION

MODEL _____
REGISTRATION OR
LICENSE NUMBER _____

VIN | | | | | | | | | | | | | | | | | | | | | |

NEW OWNER'S NAME _____

NEW OWNER'S ADDRESS _____

TELEPHONE NO. _____

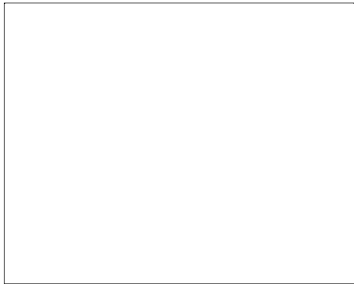

IF RESOLD BY CHRYSLER JEEP DEALERSHIP,
ENTER DEALER STAMP IN BOX ABOVE.

FIRST OWNER

80f40712

CHANGE OF OWNERSHIP NOTIFICATION

MODEL _____
REGISTRATION OR
LICENSE NUMBER _____

VIN | | | | | | | | | | | | | | | | | | | | | |

NEW OWNER'S NAME _____

NEW OWNER'S ADDRESS _____

TELEPHONE NO. _____

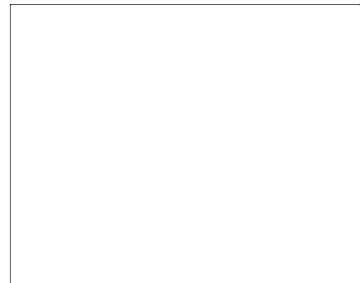

IF RESOLD BY CHRYSLER JEEP DEALERSHIP,
ENTER DEALER STAMP IN BOX ABOVE.

SECOND OWNER

80140753

INDEX

Additives, Fuel	80	Torque Converter	72	Cargo Area Cover	50
Air Cleaner, Engine	100	Auxiliary Electrical Outlet	48	Cargo Area Features	49
Air Conditioner Maintenance	102	Auxiliary Power Outlet	48	Cargo Compartment	49
Air Conditioning	61,102	Axle Fluid	109	Light	49
Air Conditioning System	61			Luggage Carrier	51
Air Filter	100	Battery	101	Cargo Light	49
Air Pressure, Tires	82	Emergency Starting	91	Cargo Tie-Downs	50
Airbag	18	Gas Caution	102	Carpeting	111
Airbag Deployment	20	Saving Feature	37	Catalytic Converter	100
Airbag Light	22,25,58	Belts, Drive	100	Chains, Tire	83
Airbag Maintenance	21	Belts, Seat	15	Check Engine Light	58
Alarm	13	Body Mechanism Lubrication	103	Checks, Safety	25
Alignment and Balance	82	Brake System	106	Child Restraint Tether Anchors	23
Anti-Lock Brake System	77	Anti-Lock	59,77	Child Safety Locks	11
Anti-Lock Warning Light	59	Hoses	106	Clean Air Gasoline	80
Appearance Care	110	Master Cylinder	107	Climate Control	61
Auto Down Power Windows	14	Parking	76	Compass	45
Automatic Dimming Mirror	30	Trailer Towing	84	Compass Calibration	45
Automatic Door Locks	11	Warning Light	60	Compass Variance	45
Automatic Temperature Control	62	Brake/Transmission Interlock	70	Computer, Trip/Travel	44
Automatic Temperature Control	62	Bulb Replacement	113	Console, Overhead	22,42
Recalibration	22,24			Converter, Catalytic	100
Automatic Transmission	70,107	Calibration, Compass	45	Coolant Pressure Cap	104
Adding Fluid	108	Camper	84	Cooling System	104
Fluid and Filter Changes	109	Capacities, Fluid	114	Adding Coolant (Antifreeze)	104
Fluid Level Check	107,108	Capacity, Cargo Weight	85	Coolant Level	105
Fluid Type	107	Caps, Filler		Disposal of Used Coolant	105
Gear Ranges	70,73	Fuel	80	Inspection	104,105
Overdrive	71	Car Washes	110	Points to Remember	105
Shifting	70	Carbon Monoxide Warning	25	Pressure Cap	104
Special Additives	109			Radiator Cap	104

Selection of Coolant	104	Electronic Vehicle Information Center	42	Exterior Finish Care	110
Temperature Gauge	59	Emergency, In Case of		Filters	
Cruise Control	40	Brake Warning Light	60	Air Cleaner	100
Cruise Light	58	Coolant Temperature Gauge	59	Engine Fuel	100
Cup Holder	49	Engine Oil Pressure Gauge	58	Engine Oil	100
Customer Assistance	142	Freeing Vehicle When Stuck	72	Engine Oil Disposal	99
		Hazard Warning Flasher	88	Finish Care	110
Defroster, Rear Window	64	Jacking	90	Flashers	88
Defroster, Windshield	25,62,63	Jump Starting	91	Hazard Warning	88
Diagnostic System, Onboard	98	Tow Hooks	92	Turn Signal	58
Diesel Engine Maintenance	129	Emission Related Components	22	Flat Tire Stowage	90
Diesel Fuel	80	Engine		Flipper Glass, Tailgate	10
Diesel Fuel Requirements	80	Air Cleaner	100	Flooded Engine Starting	68
Dimmer Switch, Headlight	38	Break-In Recommendations	24	Fluid Capacities	114
Dipsticks		Compartment	95,96,97	Fluid Leaks	25
Automatic Transmission	108	Data Label	22,24	Fluid Level Checks	
Oil (Engine)	98	Exhaust Gas Caution	25	Automatic Transmission	108
Disposal		Fails to Start	68	Cooling System	105
Used Coolant	105	Jump Starting	91	Engine Oil	98
Door Locks	10,11	Malfunction Indicator	58	Power Steering	102
Door Locks, Automatic	11	Oil	98	Transfer Case	109
Drive Belts	100	Oil Change Interval	98	Fog Lights	37
Driving	78	Oil Filter	100	Four-Way Hazard Flasher	88
Off-Pavement	78	Oil Pressure Gauge	58	Freeing A Stuck Vehicle	72
On Hills	78	Oil Selection	99	Fuel	79
On Slippery Surfaces	78	Overheating	88	Additives	80
		Starting	68	Filler Cap	80
Electric Remote Mirrors	31	Temperature Gauge	59	Filler Door	80
Electrical Outlet, Auxiliary	48	Entry System, Illuminated	10	Filter	100
Electronic Speed Control	40	Exhaust Gas Caution	25		
		Exhaust System	103		

Gasoline	79	Holder, Cup	49	Lap/Shoulder Belts	15
Gauge	60	Hood Release	36	Leaks, Fluid	25
Octane Rating	79	Hoses	106	Liftgate Flipper Glass	10
Requirements	80	Identifying Your Engine	96,97	Liftgate Window Wiper/Washer	64
Fuses	112	Ignition		Lights	25,36
Gas Cap	80	Key	9	Airbag	22,58
Gasoline	79	Illuminated Entry	10	Alarm	25
Gasoline, Clean Air	80	Immobilizer	9	Anti-Lock	59
Gauges		Inflation Pressure Tires	82	Brake Warning	60
Coolant Temperature	59	Information Center, Vehicle	42	Cargo	49
Fuel	60	Inside Rearview Mirror	30	Check Engine	58
Odometer	59	Instrument Cluster	55,58	Check Gauges	59
Oil Pressure	58	Instrument Panel and Controls	54	Cruise	58
Speedometer	58	Interior Appearance Care	111	Dimmer Switch, Headlight	37,38
Tachometer	58	Interior Fuses	112	Dome	42
Voltmeter	58	Interior Lighting	36	Fog	37
Gear Ranges	70,73	Intermittent Wipers	39	Fuses	112
Glass Cleaning	111	Introduction	4	Glow Plug Light	60
Glove Compartment	49	Jack Location	88	Hazard Warning Flasher	88
Glow Plug Light	60	Jack Operation	90	Headlight Leveling	38
Hazard Warning Flasher	88	Jump Starting	91	Headlight Switch	37
Head Restraints	32	Key-In Reminder	9	High Beam Indicator	58
Head Rests	32	Keyless Entry System	12	Instrument Cluster	37
Headlights	37	Keys	9	Interior	36
High Beam	58	Lane Change and Turn Signals	58	Lights On Reminder	37
Leveling	38			Low Coolant	60
Time Delay	38			Low Fuel	60
Heated Seats	35			Malfunction Indicator	58
				Passing	38
				Reading	36,42
				Rear Fog	38

Seat Belt Reminder	59	Mirrors	30	Overdrive	71
Sentry Key	58	Automatic Dimming	30	Overhead Console	42
Turn Signal	38,58	Electric Powered	31	Overheating, Engine	88
Vanity Mirror	31	Electric Remote	31	Parking Brake	76
Water in Fuel	60	Exterior Folding	30	Passing Light	38
Locks	10	Heated	31	Polishing and Waxing	110
Automatic Door	11	Outside	30	Power	
Child Protection	11	Rearview	30	Distribution Center	113
Door	10,11	Vanity	31	Door Locks	11
Liftgate, Tailgate	10	Mopar Parts	98	Mirrors	31
Power Door	11	Multi-Function Control Lever	37	Outlet	48
Lubrication, Body	103	Occupant Restraints	15	Seats	33
Lug Nuts	91	Octane Rating, Gasoline	79	Steering, Checking	102
Luggage Rack	51	Odometer	59	Sunroof	47
Lumbar Support	33	Trip	59	Windows	14
Maintenance Procedures	98	Off-Road Driving	78	Pregnant Women and Seat Belts	18
Maintenance Schedule	118,129	Oil, Engine	98	Pressure Gauge, Oil	58
Diesel	129	Change Interval	98	Programmable Electronic Features	43
Light Duty Schedule "A"	126,133	Dipstick	98	Quadra-Trac	74
Light Duty Schedule "B"	119,130	Disposal	99	Radiator Cap	104
Schedule "A"	126,133	Filter	100	Radio	61
Schedule "B"	119,130	Filter Disposal	99	Rain Sensitive Wiper System	39
Maintenance Schedules	118	Identification Logo	99	Rear Axle	109
Malfunction Indicator Light	58	Materials Added to	99	Rear Liftgate	10
Master Cylinder	107	Pressure Gauge	58	Rear Window Defroster	64
Memory Seats and Radio	34	Viscosity	99	Rear Window Features	64
Methanol	79	Oil Filter, Selection	100	Rear Wiper/Washer	64
Methanol Fuel	79	Onboard Diagnostic System	98		
Mini-Trip Computer	44	Outside Rearview Mirrors	30		

Rearview Mirrors	30	Memory	34	Temperature Control, Automatic	62
Reclining Front Seats	32	Power	33	Temperature Gauge, Engine Coolant	59
Recommended Fluids, Lubricants and Genuine Parts	114	Rear Folding	35	Tether Anchor, Child Restraint	23
Remote Keyless Entry	12	Security Against Theft	11	Tie Down Hooks, Cargo	50
Replacement Bulbs	113	Security Alarm	13	Tilt Steering Column	40
Replacement Tires	83	Sentry Key	9	Tires	25,81
Restraints, Occupant	15	Service Assistance	142	Air Pressure	82
Retractable Cargo Area Cover	50	Shifting		Break-In	82
Rocking Vehicle When Stuck	72	Automatic Transmission	70	Chains	83
Roof Type Carrier	51	Shoulder Belts	15	Changing	88,90
Rotation, Tires	82	Signals, Turn	58	Inflation Pressures	82
Safety Checks Inside Vehicle	25	Slippery Surfaces, Driving On	78	Jacking	90
Safety Checks Outside Vehicle	25	Snow Tires	83	Maintenance	81
Safety Tips	25	Sound Systems	61	Replacement	83
Schedule, Maintenance	129	Sound Systems	<i>Refer to the Sound Systems Booklet</i>	Rotation	82
Seat Belt Maintenance	25	Spare Tire	89	Safety	25
Seat Belts	15	Spark Plugs	100	Spare Tire	89
Adjustable Upper Shoulder Anchorage	17	Speed Control	40	Spinning	84
And Pregnant Women	18	Speedometer	58	Tread Wear Indicators	84
Front Seat	15	Starting	68	Wheel Mounting	90
Inspection	25	Automatic Transmission	68	Wheel Nut Torque	91
Maintenance	25	Emergency (Jump Starting)	91	Tongue Weight/Trailer Weight	85
Reminder	59	Engine Fails to Start	68	Torque Converter Clutch	72
Shoulder Belt Anchorage	17	Steering		Tow Hooks, Emergency	92
Seats	31	Wheel, Tilt	40	Towing	84
Adjustment	32	Sun Roof	47	Trailer	84
Head Restraints	32	Supplemental Restraint System - Airbag	18	Trailer Towing	84
Heated	35	Tachometer	58	Minimum Requirements	85
				Trailer and Tongue Weight	85
				Transfer Case	74,109

Transmission			
Automatic	70,107		
Filter	109		
Fluid	107		
Maintenance	107		
Shifting	70,73		
Tread Wear Indicators	84		
Trip Computer	44		
Trip Odometer	59		
Trip Odometer Reset Button	59		
Turn Signals	38,58		
Underhood Fuses	113		
Upholstery Care	111		
		Vacuum/Vapor Harnesses	106
		Vanity Mirrors	31
		Variance, Compass	45
		Vehicle Identification Number	6
		Vinyl Trim	111
		Voltmeter	58
		Warning Flasher, Hazard	88
		Warnings and Cautions	6
		Washers, Windshield	39
		Washing Vehicle	110
		Water in Fuel	80
		Waxing and Polishing	110
		Wheel Alignment and Balance	82
		Wheel Changing	90
		Wheel Mounting	90
		Wheel Nut Torque	91
		Wind Buffeting	14
		Window Fogging	63
		Windows	
		Power	14
		Windshield Defroster	25,62,63
		Windshield Washers	39,103
		Windshield Wiper Blades	103
		Windshield Wipers	39
		Wipers, Intermittent	39
		Wipers, Rain Sensitive	39

